

Druckluftmotor
Air motor
Moteur à air comprimé

MRD 12-3250
29905865

MANNESMANN
DEMAG

Nr.	BENENNUNG	DESCRIPTION	DESIGNATION	Lager-Nr. Stock-No. No. de magasin	STÜCK QUTY.
No.					
1	Flansch	flange	bride	48102173	1
2	Dichtring	seal ring	anneau de joint	9321908	1
3	Planetengetriebe	planetary gearing	engrenage planétaire	48103205	1
3.1	Rillenkugellager	ball bearing	roulement à billes	9357066	2
3.2	Plantenradträger	planetary carrier	cage de transmission planétaire	48103193	1
3.3	Planetenrad	planetary gear pinion	roue planetaire	03139274	2
3.4	Lagernadel	bearing needle	aiguille de palier	9357483	26
3.5	Lagernadel	bearing needle	aiguille de palier	9357216	2
3.6	Zahnkranz	gear ring	couronne dentée	48103063	1
4	Scheibenfeder	Woodruff key	clavette disque	9316806	1
5	Distanzring	distance ring	entretoise	48105003	1
6	Motorblock	motor	moteur	29910195	1
6.1	Rillenkugellager	ball bearing	roulement à billes	9357214	1
6.2	Lagerschild vorne	end plate front	flasque de palier	48101023	1
6.3	Lamelle	vane	palette	29300246	5
6.4	Rotor	rotor	rotor	48101123	1
6.5	Zylinder	cylinder	cylindre	48101113	1
6.6	Lagerschild hinten	end plate rear	flasque de palier	48101055	1
6.7	Spannstift	dowel pin	goupille de serrage	9335221	1
6.8	Rillenkugellager	ball bearing	roulement à billes	9357213	1
7	Lufteinlassstück	air inlet	entrée d'air	48115143	1
8	Gehäuse	housing	carter	48102303	1
9	Lufteinlass	air inlet	entrée d'air	29904663	1
10	Verschlusschraube	locking screw	bouchon	9306233	1

 30 Nm LH
Loctite 243

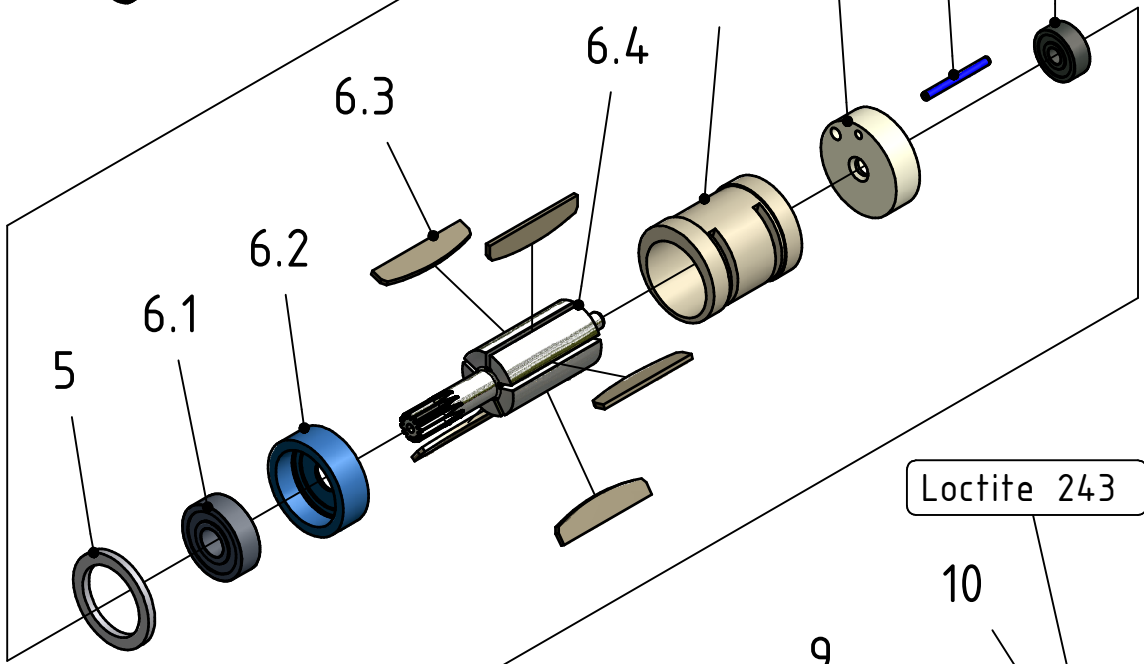
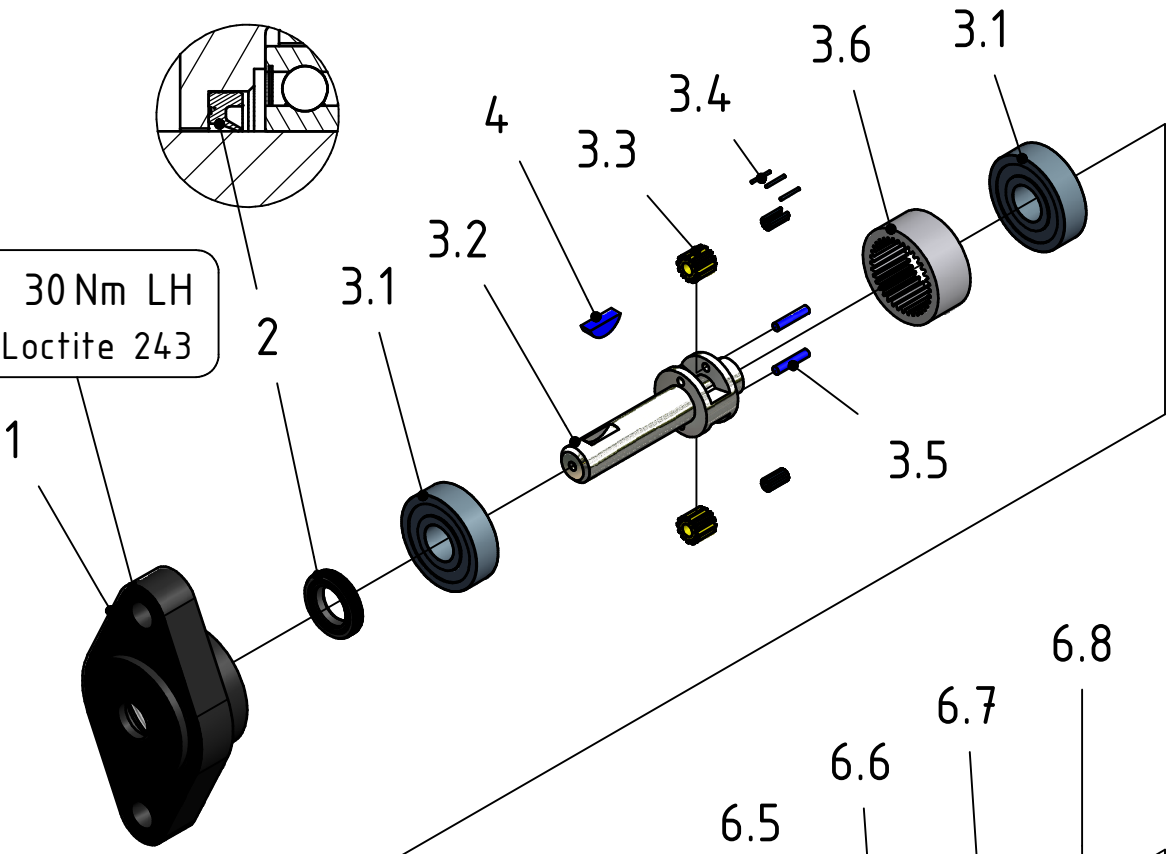

Loctite 243

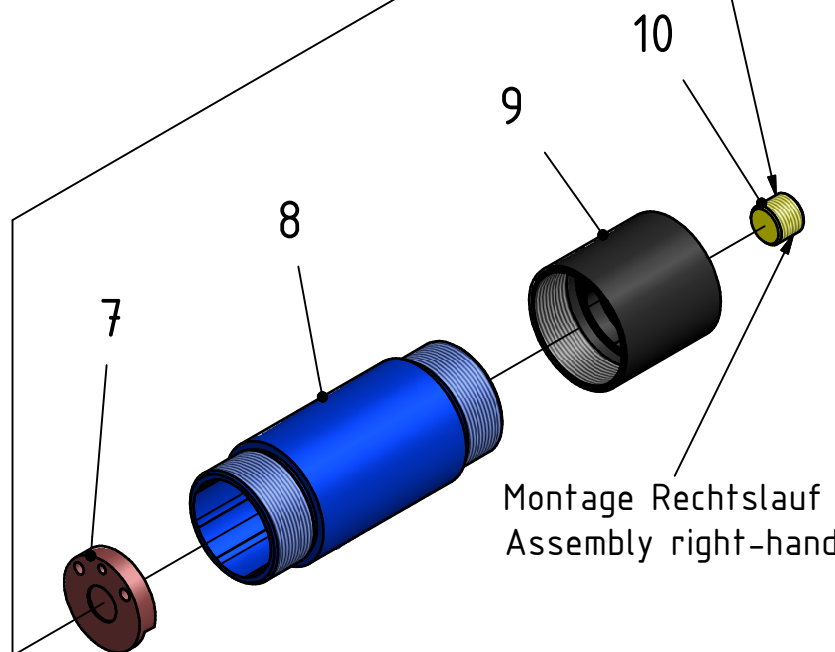

MRD 12-3250
29905865

Montage Rechtslauf
Assembly right-hand rotation