

Passfeder
feather key
DIN 6885 - 4x4x25

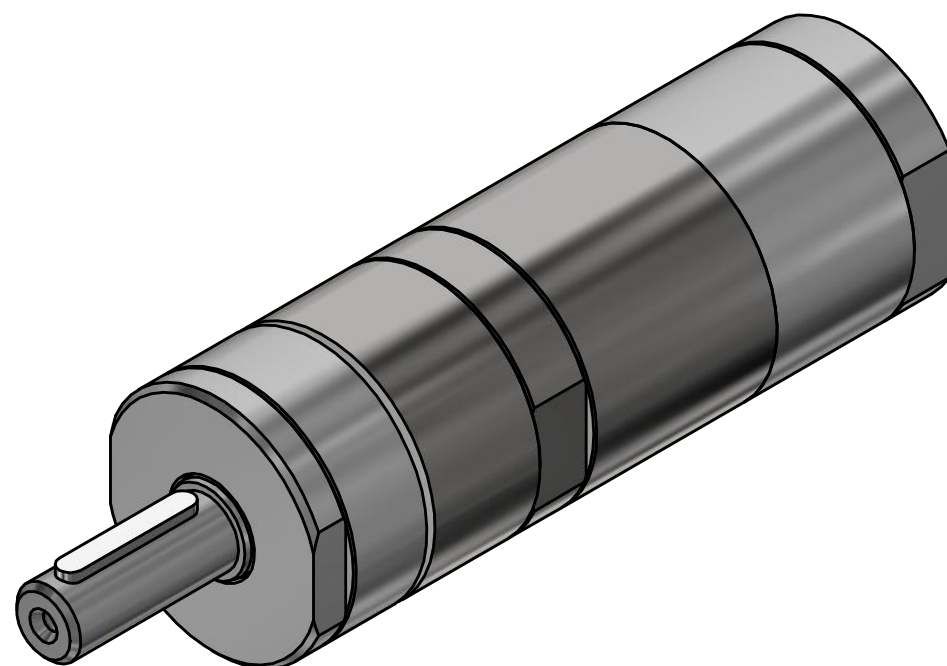
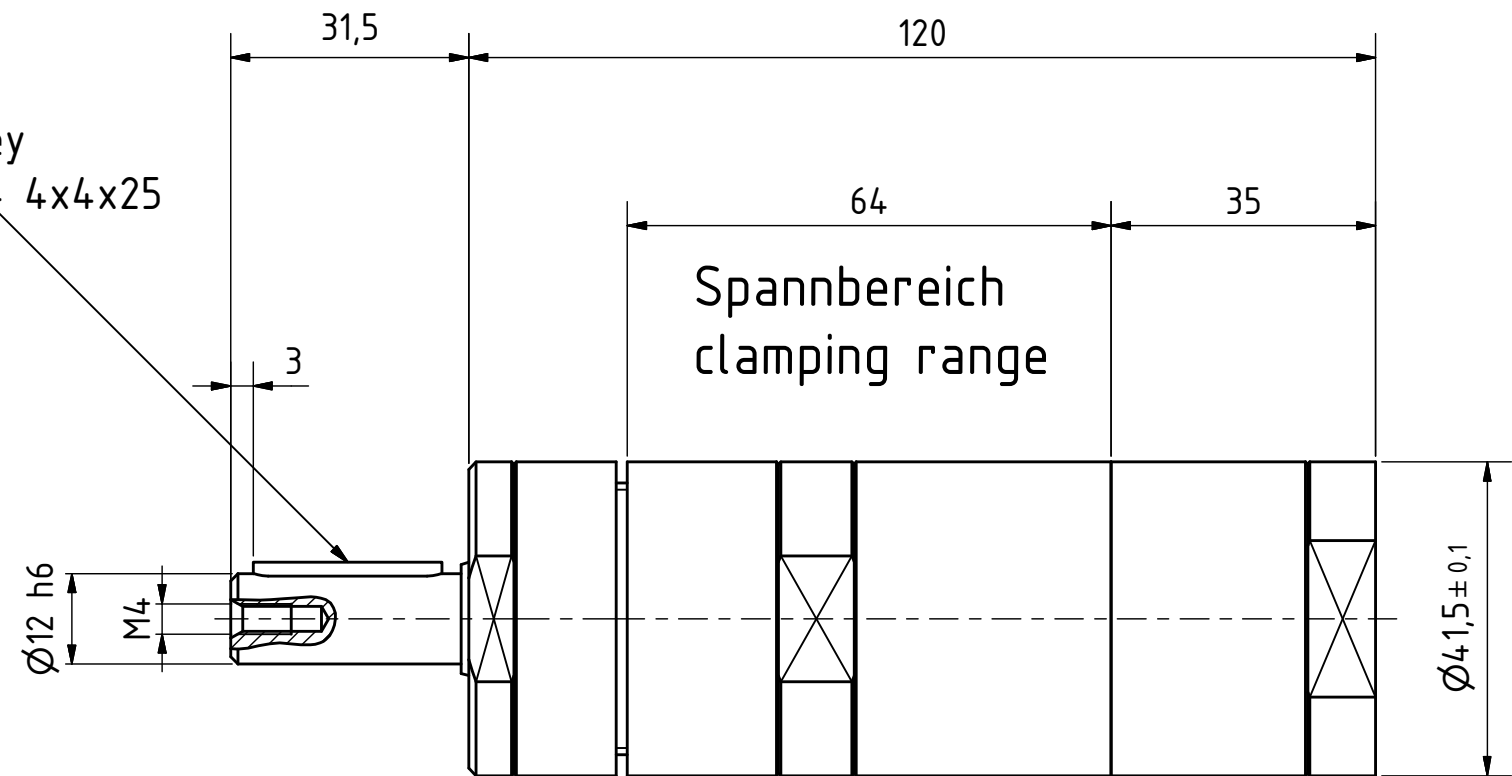

MRD 38-9400
29925987

MANNESMANN
DEMAC

Änderungsstand: - 27.03.2018