

Passfeder
feather key
DIN 6885 - 5x5x18

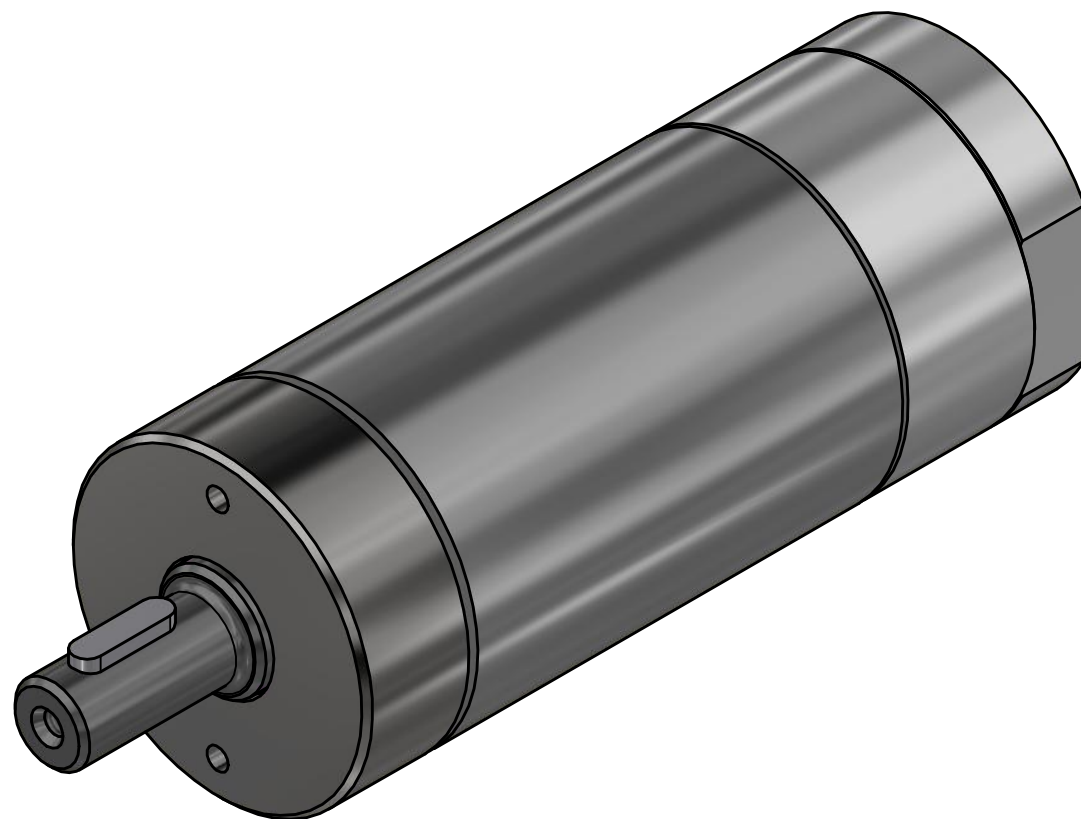
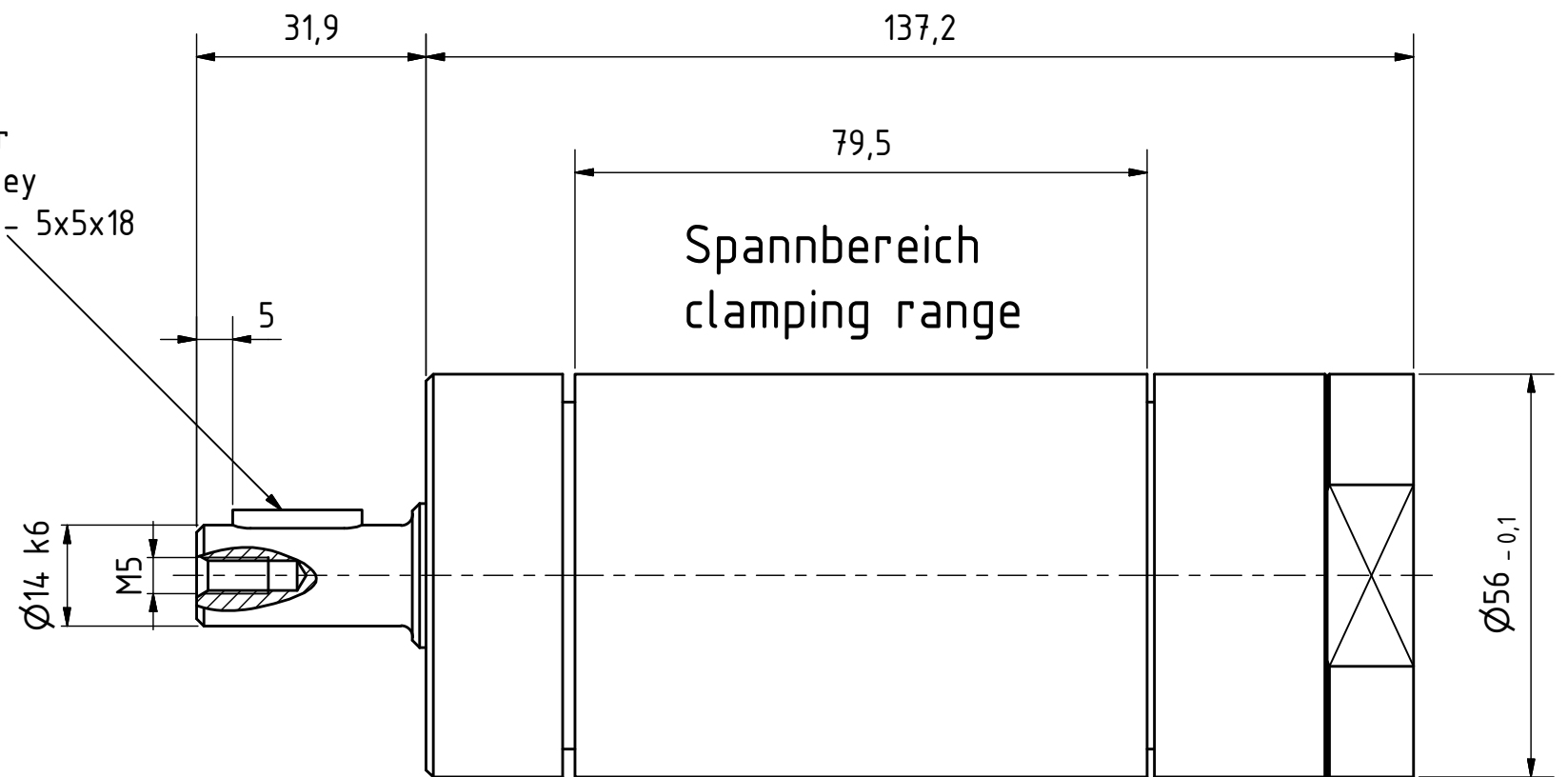

MRD 55-1800
60033277

MANNESMANN
DEMAC

Änderungsstand: -

16.11.2018