

Passfeder
feather key
DIN 6885 - 5x5x30

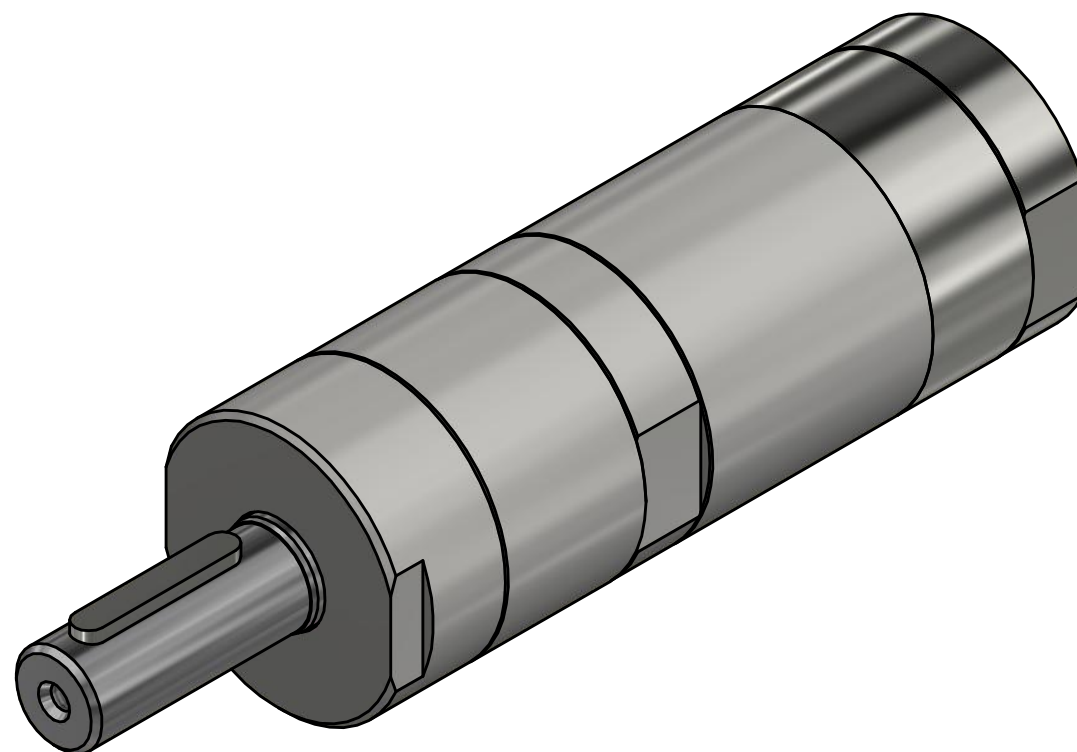
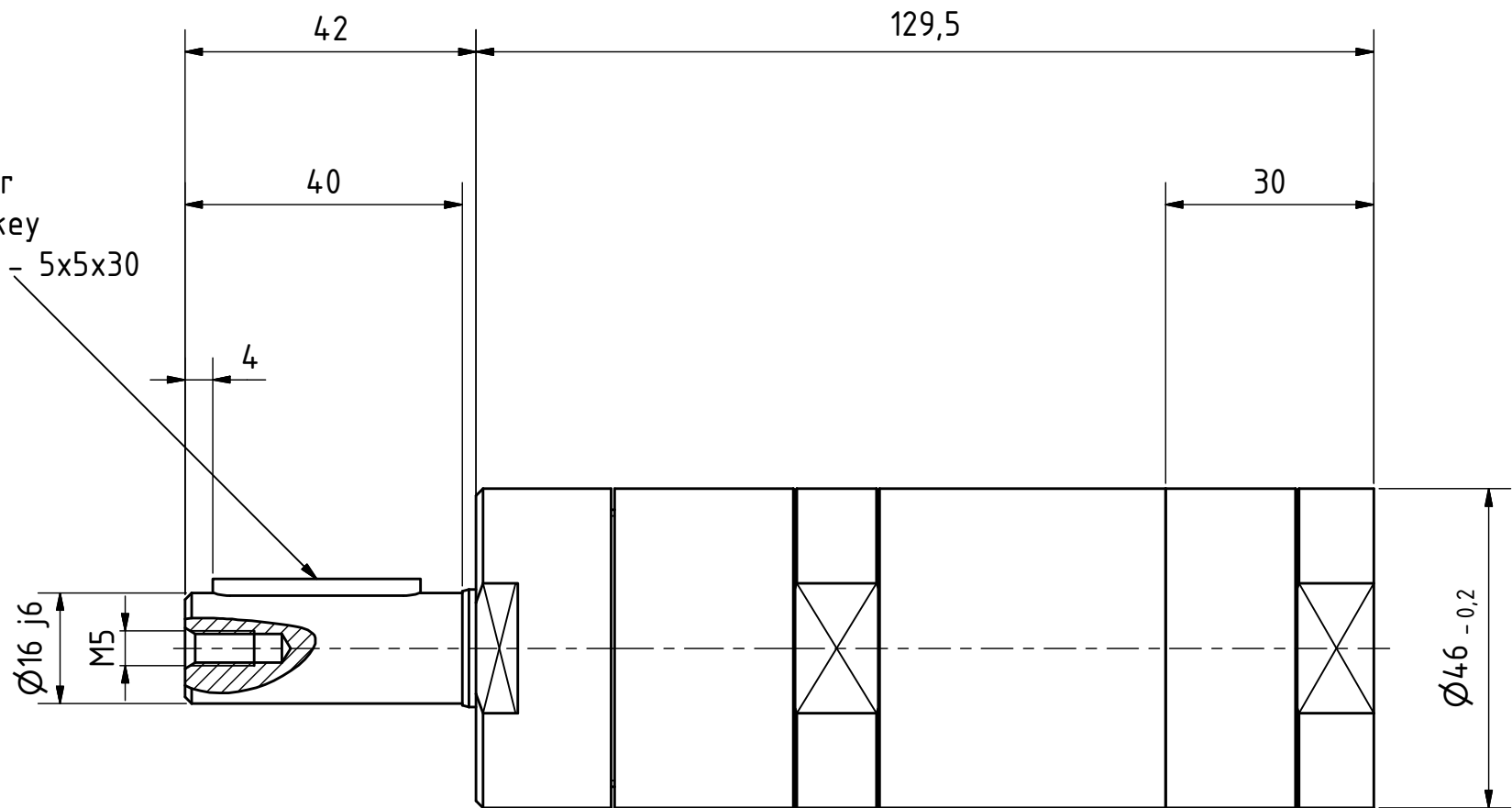

MRD 65-2900
60024567

MANNESMANN
DEMAG

Änderungsstand: -

16.01.2018