

Passfeder
feather key
DIN 6885 - 5x5x30

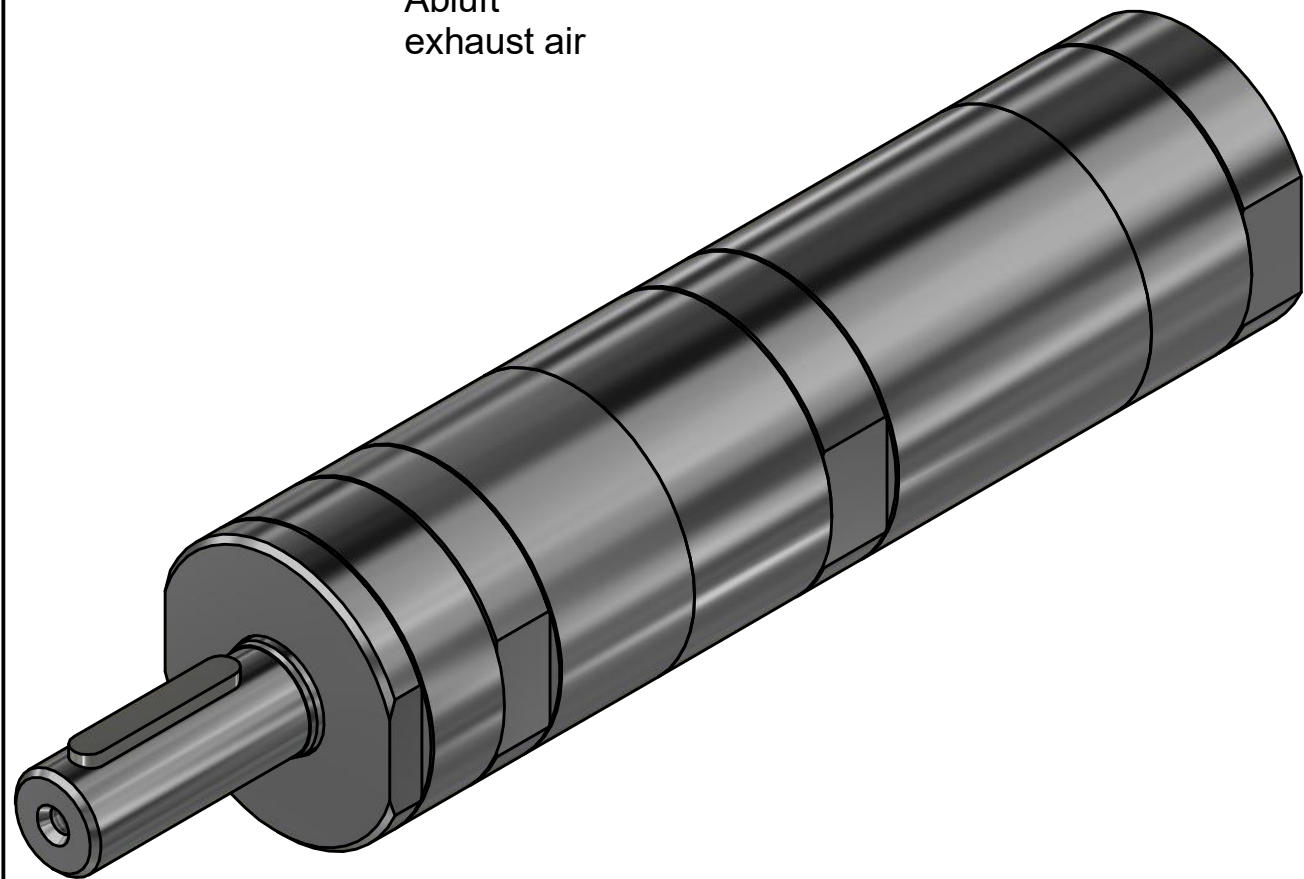
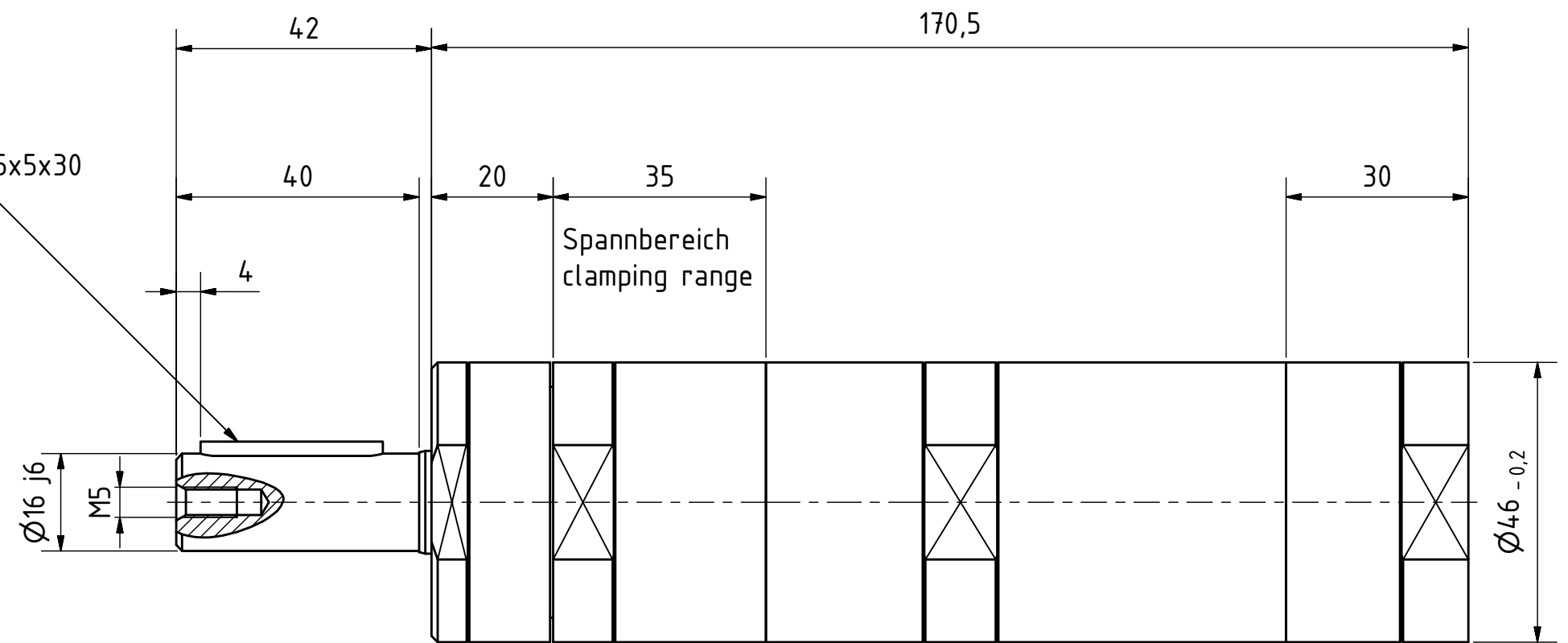

MRD 84-660
60024717

MANNESMANN
DEMAG

Änderungsstand: - 14.12.2017