

Paßfeder
Fitting key
A 10x8x50 DIN 6885

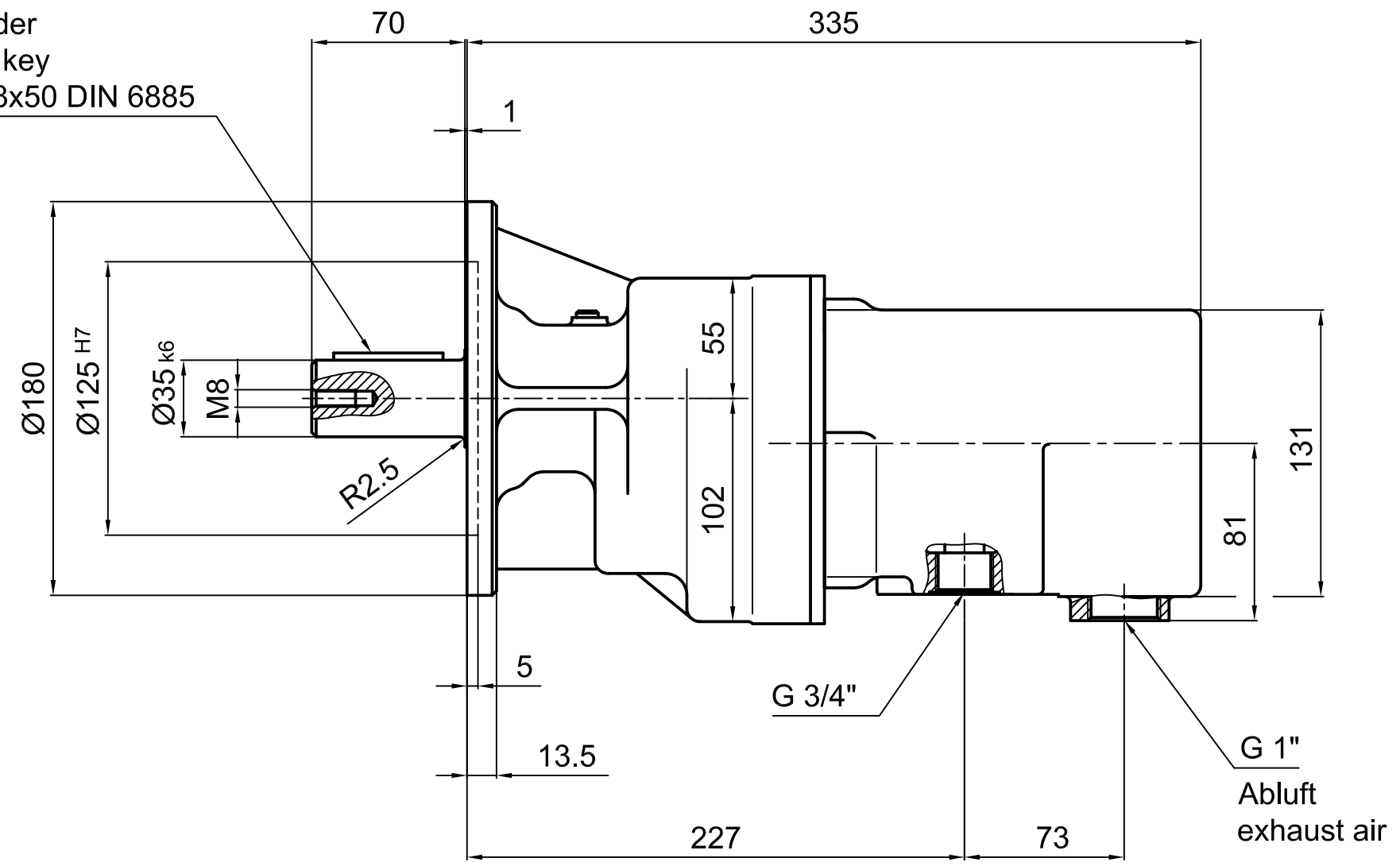

MU 300-500 KRL
60034575

