

Passfeder
fitting key
DIN 6885 - 4x4x25

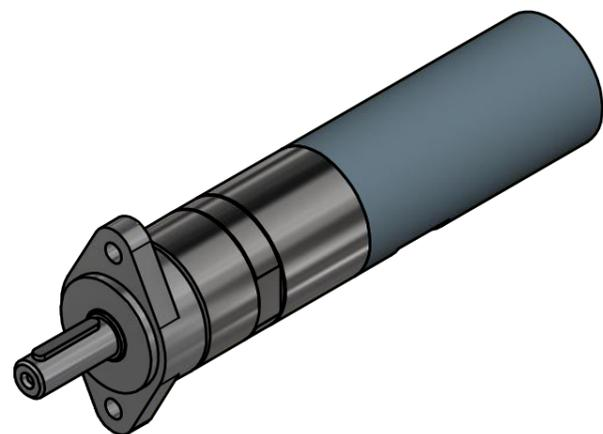
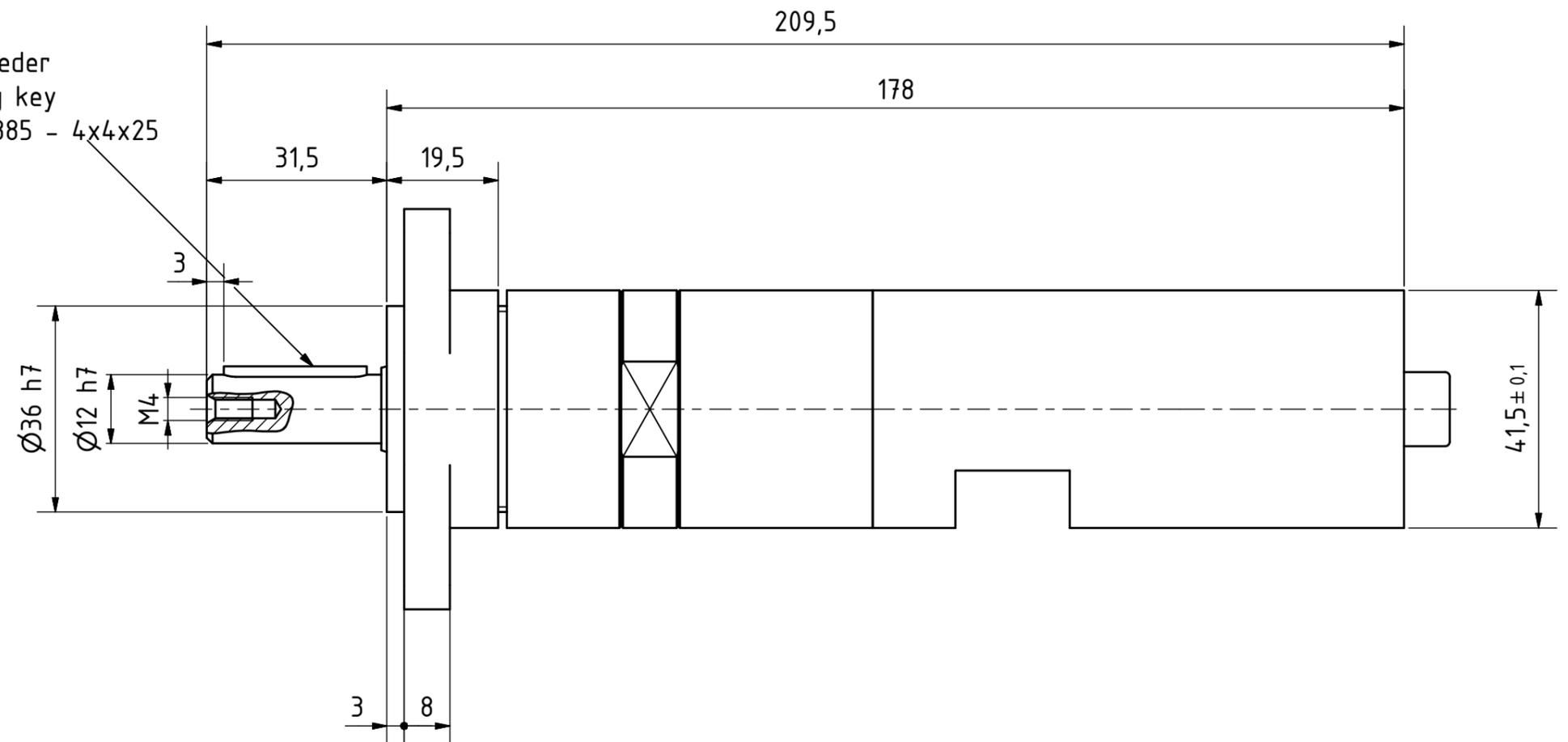

MUB 23-880 F54
60032785

MANNESMANN
DEMAC

Änderungsstand: - 08.04.2019