

Passfeder
feather key
DIN 6885 - 3x3x18

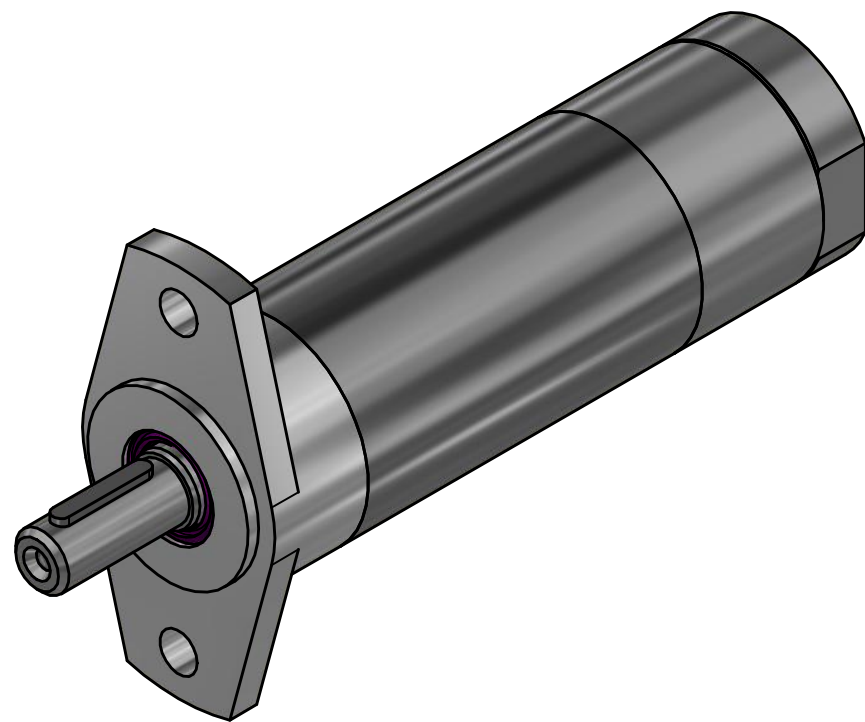
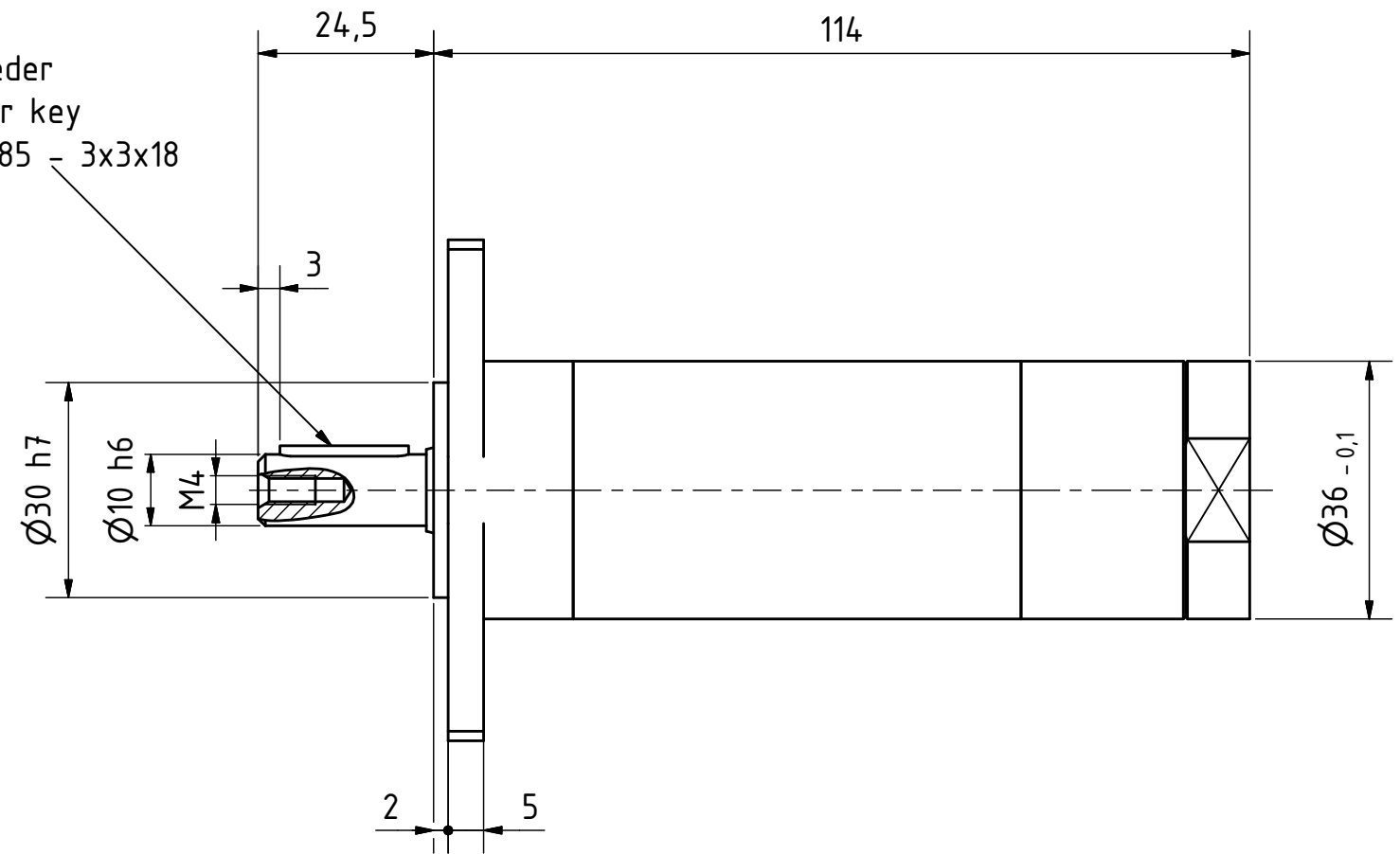

MUD 16-1050 F55
60006397

MANNESMANN
DEMAC

Änderungsstand: -

12.11.2018