

Passfeder
Feather key
DIN 6885 - 3x3x18

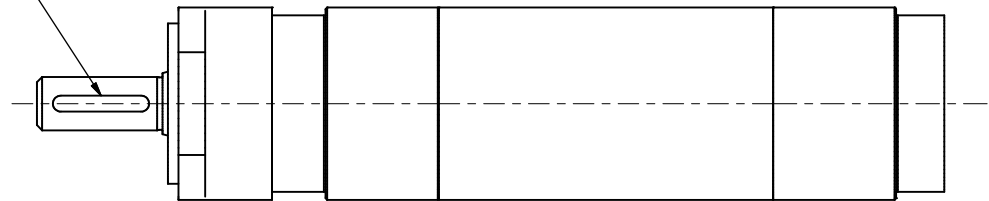

MUD 16-240 F55
60009017

MANNESMANN
DEMAG

Änderungsstand: -- 21.07.2025