

Passfeder
 feather key
 DIN 6885 - 3x3x18

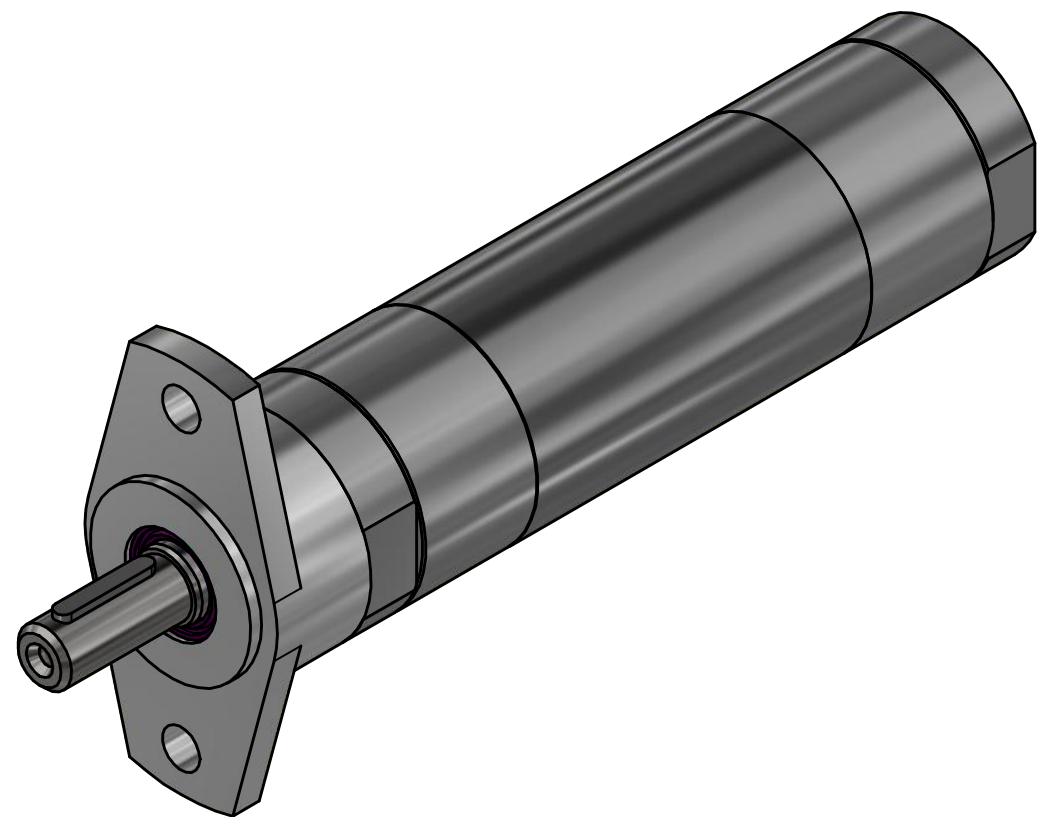
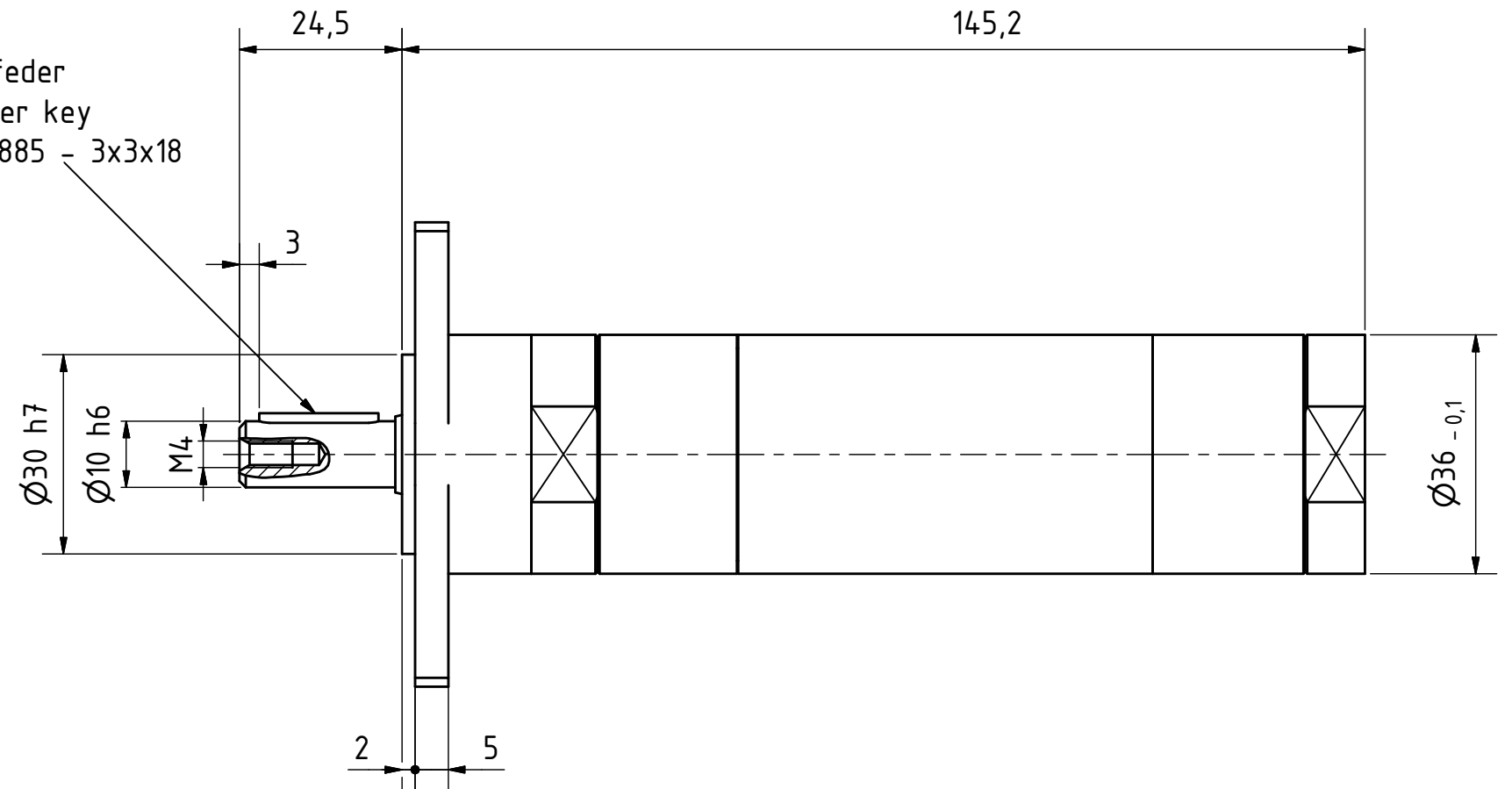

MUD 16-310 F55
 60006267

MANNESMANN
DEMAC

Änderungsstand: -

12.11.2018