

Passfeder
feather key
DIN 6885 - 3x3x18

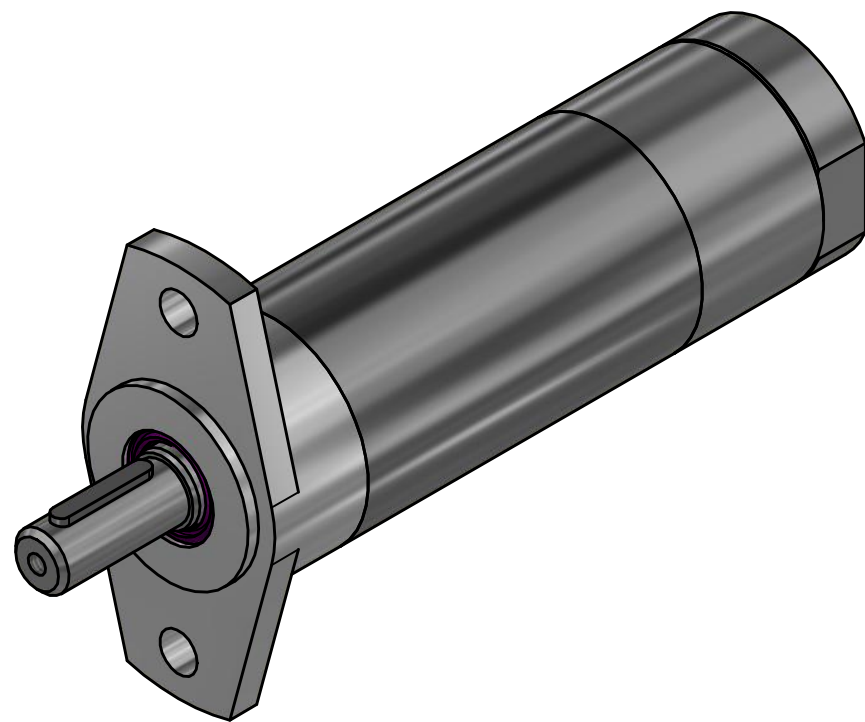
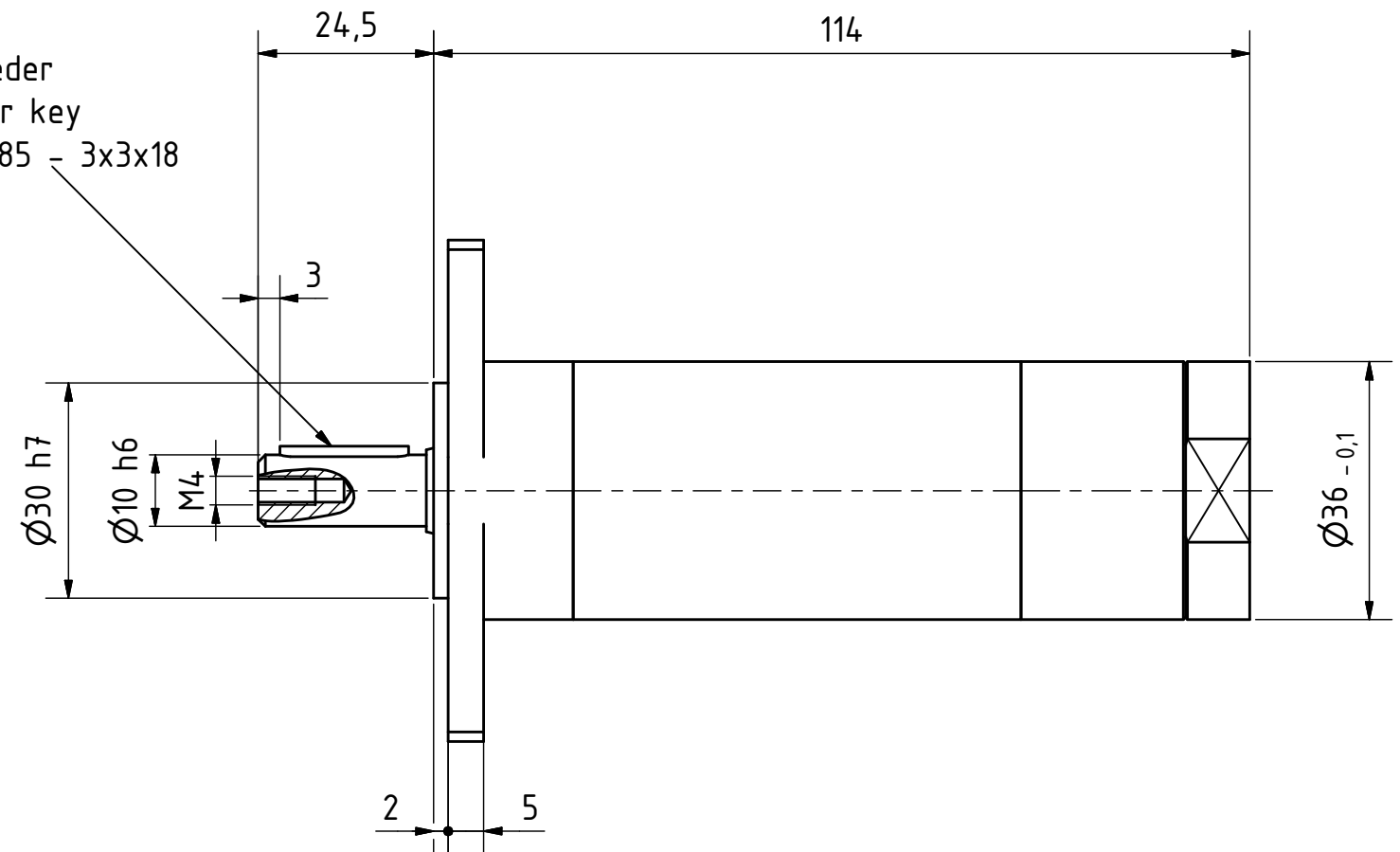

MUD 16-650 F55
60017717

MANNESMANN
DEMAC

Änderungsstand: -

12.11.2018