

Passfeder
feather key
DIN 6885 - 5x5x30

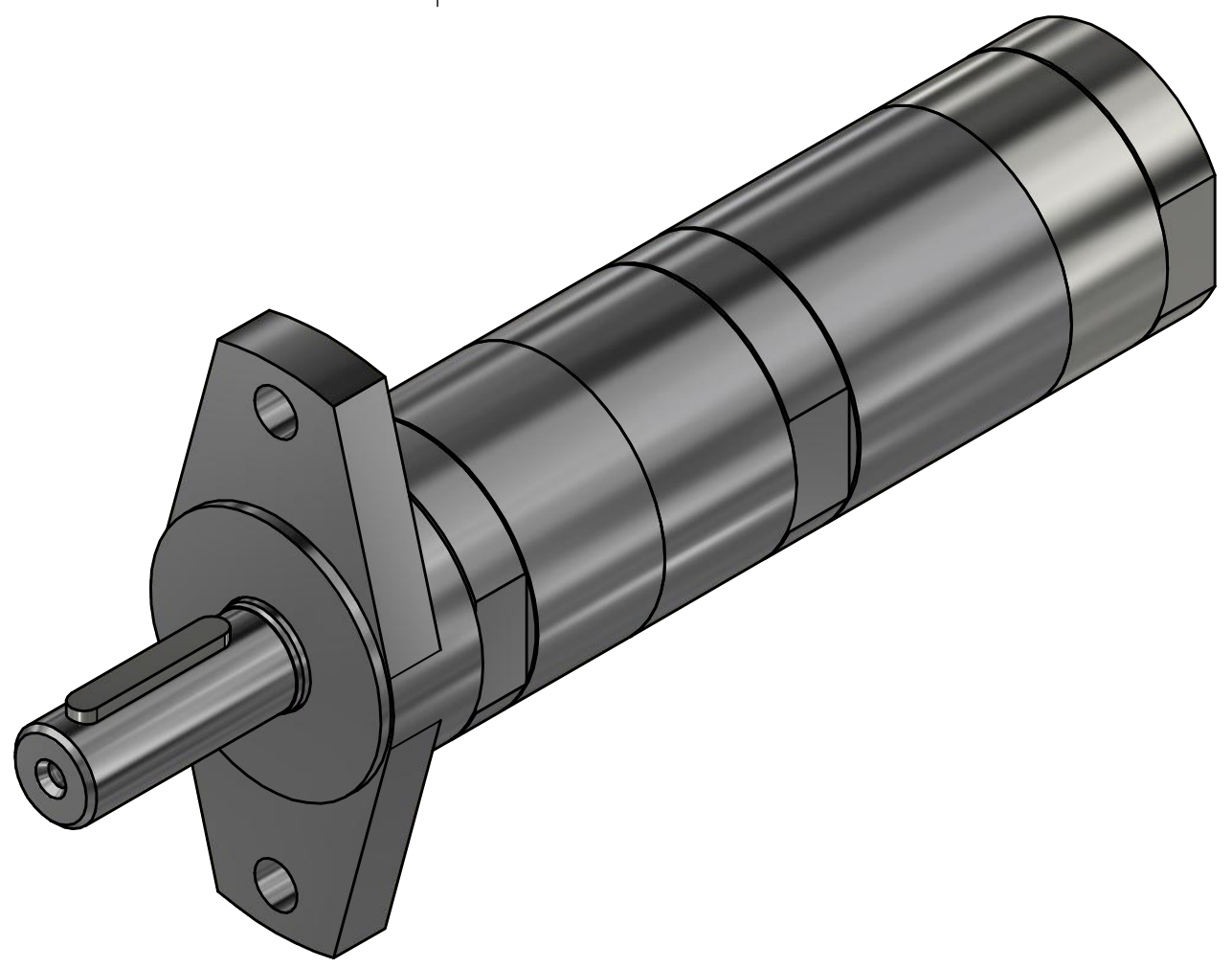
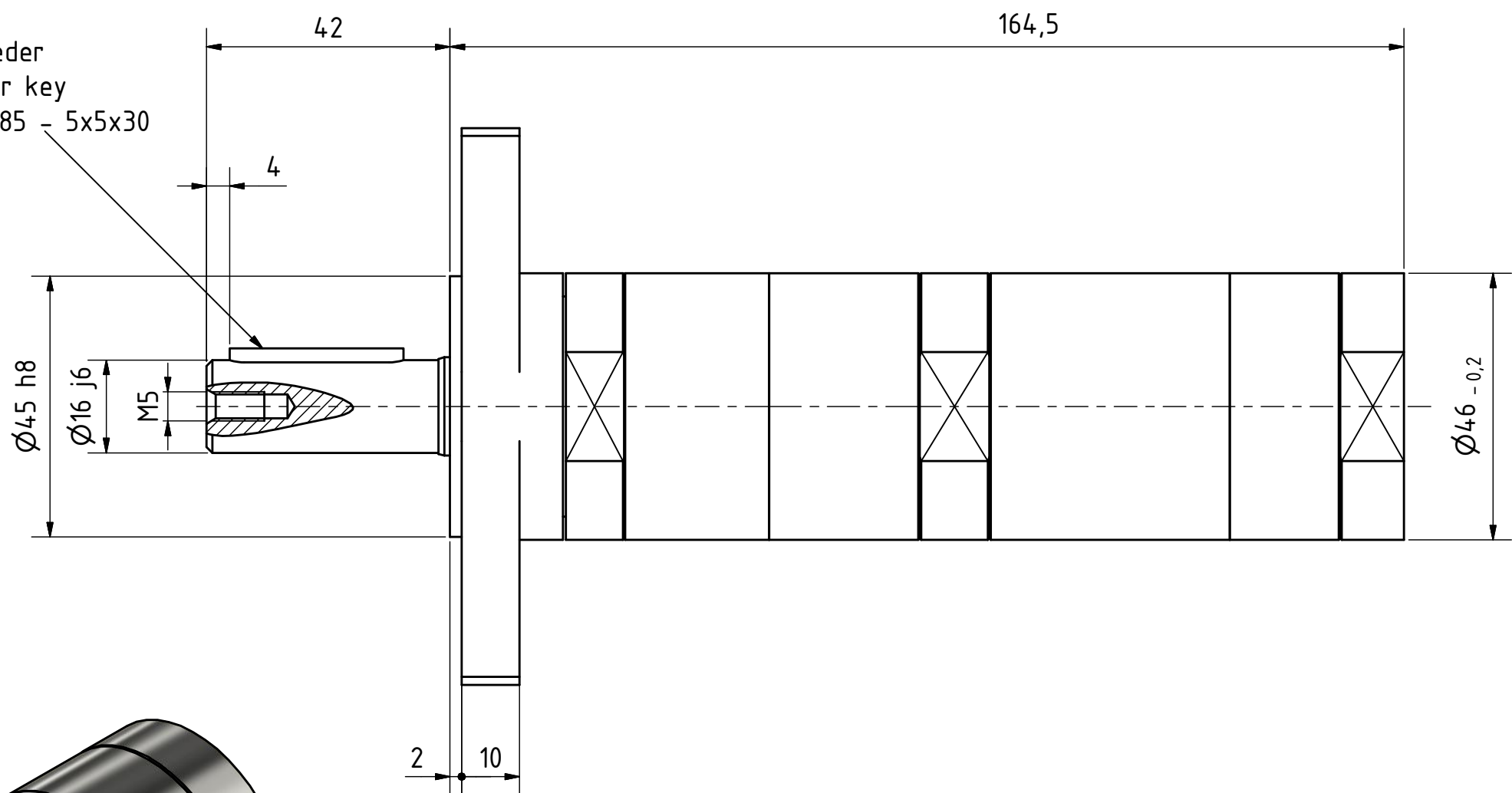

MUD 53-390 F80 60031257		MANNESMANN DEMAC
Änderungsstand: -	28.11.2018	