

Passfeder
feather key
DIN 6885 - 5x5x30

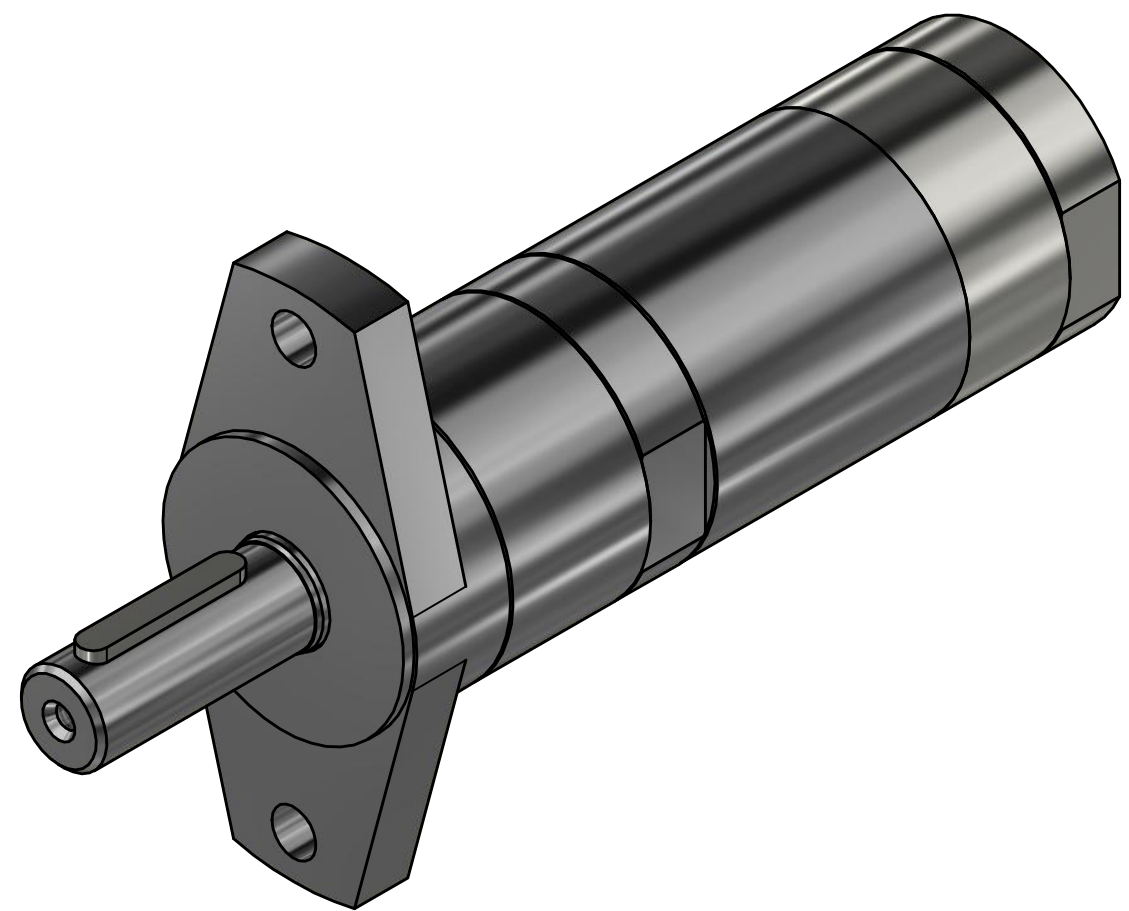
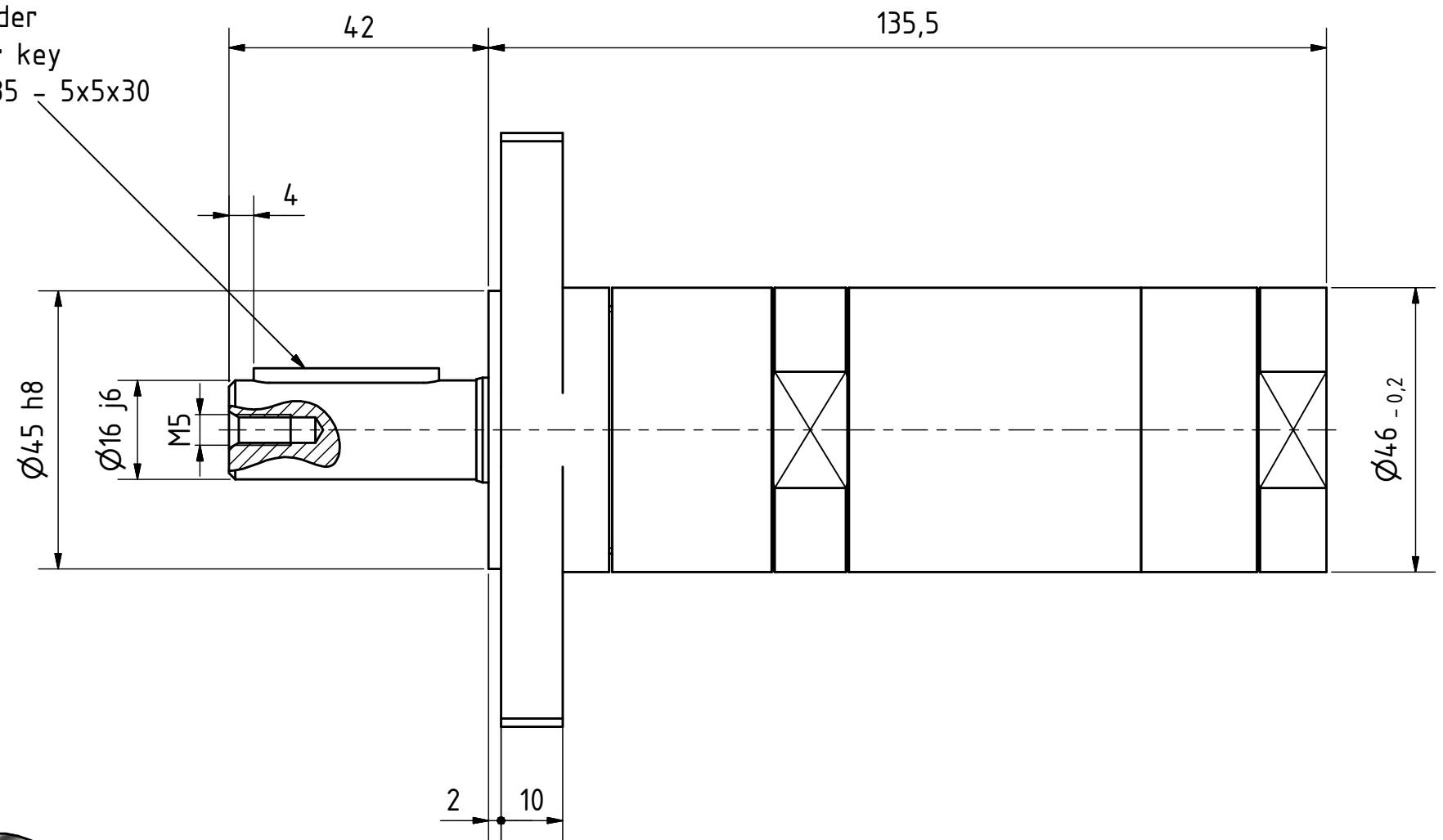

MUD 62-1890 F80
60031357

MANNESMANN
DEMAC

Änderungsstand: - 07.12.2018