

Passfeder
feather key
DIN 6885 - 5x5x30

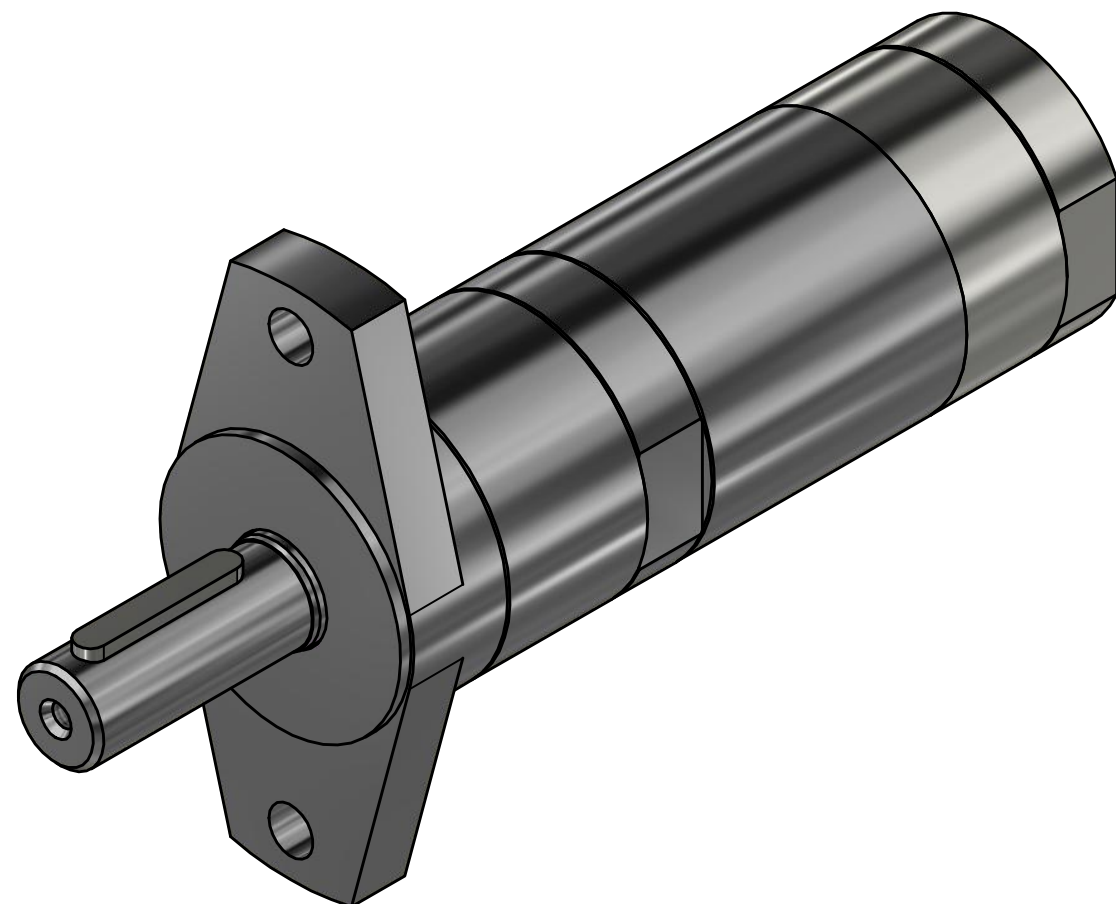
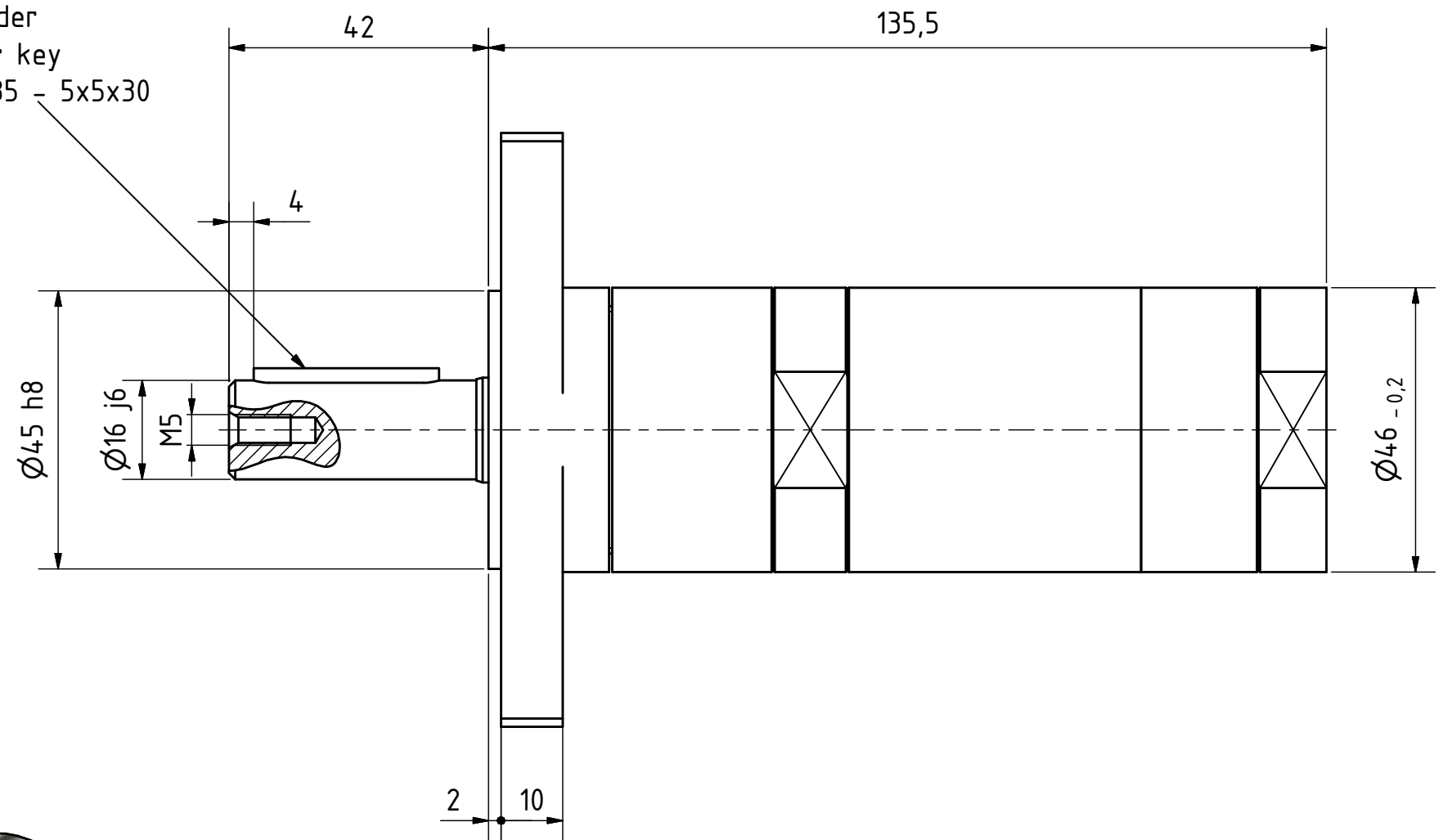

MUD 62-8600 F80
60031337

MANNESMANN
DEMAG

Änderungsstand: - 07.12.2018