

Passfeder
feather key
DIN 6885 - 5x5x30

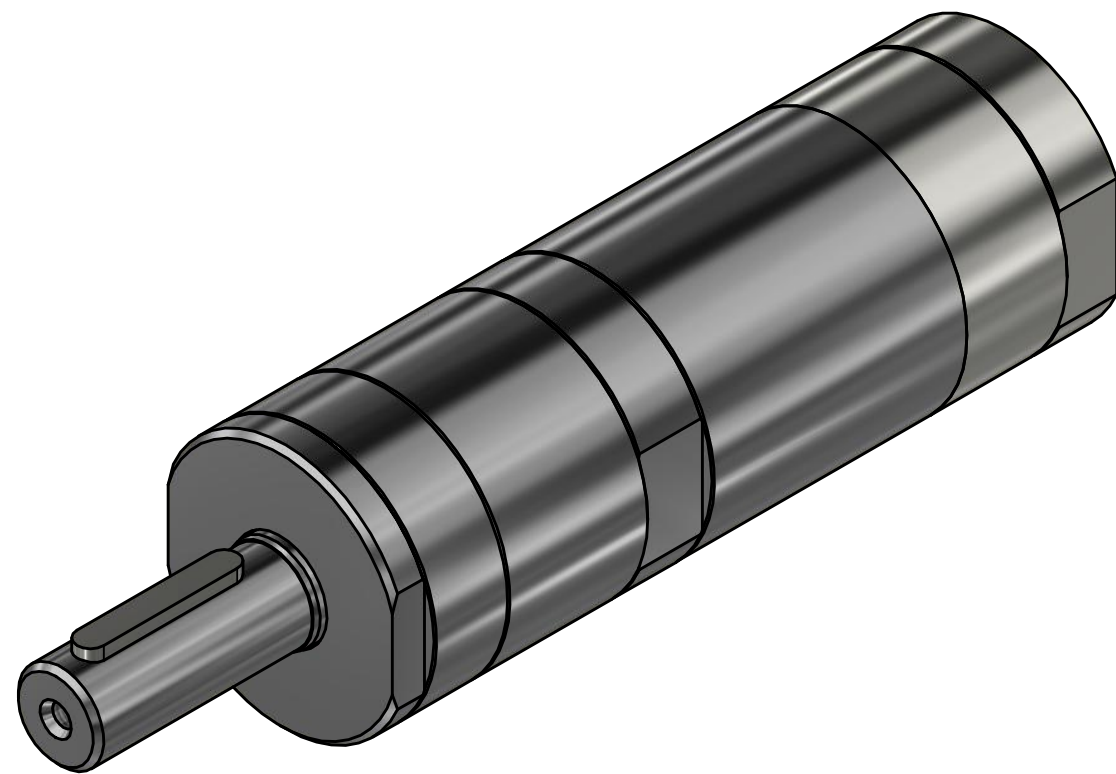
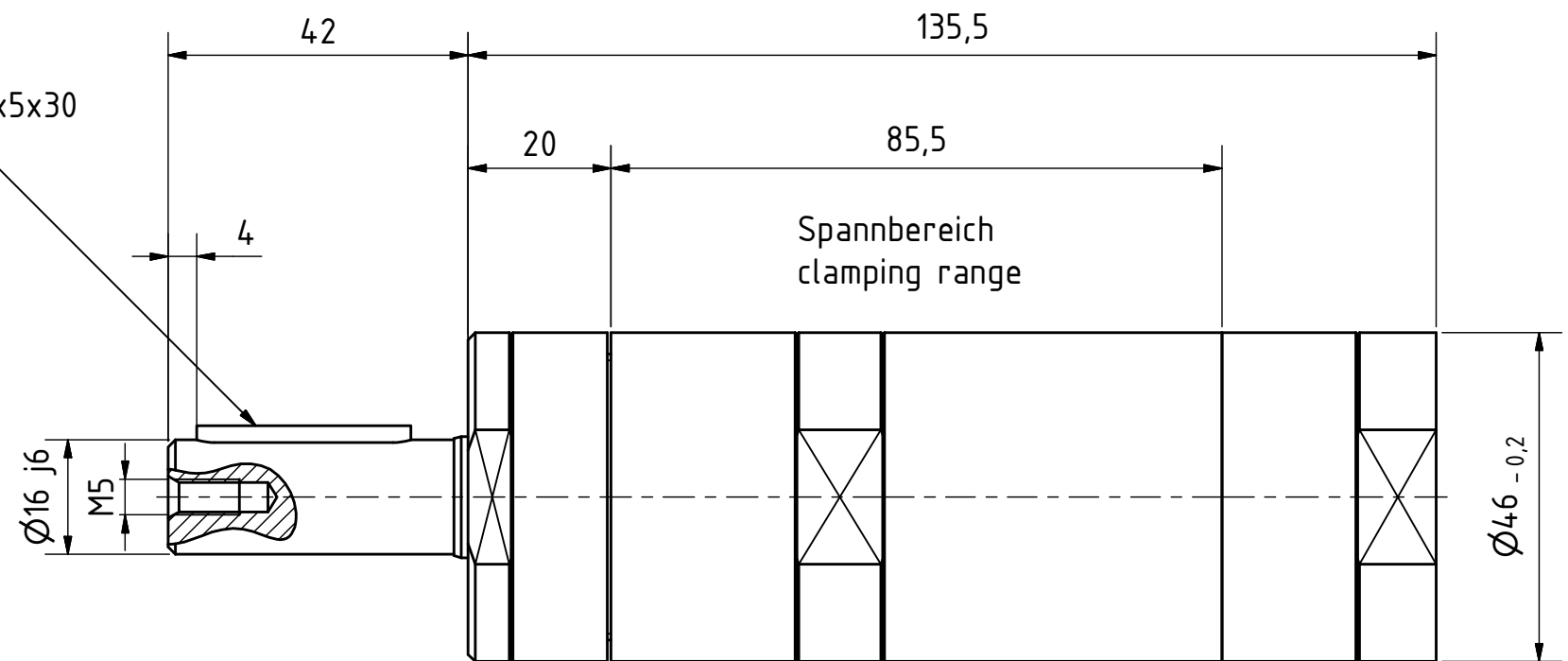

MUD 62-8600
60025397

MANNESMANN
DEMAG

Änderungsstand: -

07.12.2018