

Passfeder
feather key
DIN 6885 - 6x6x32

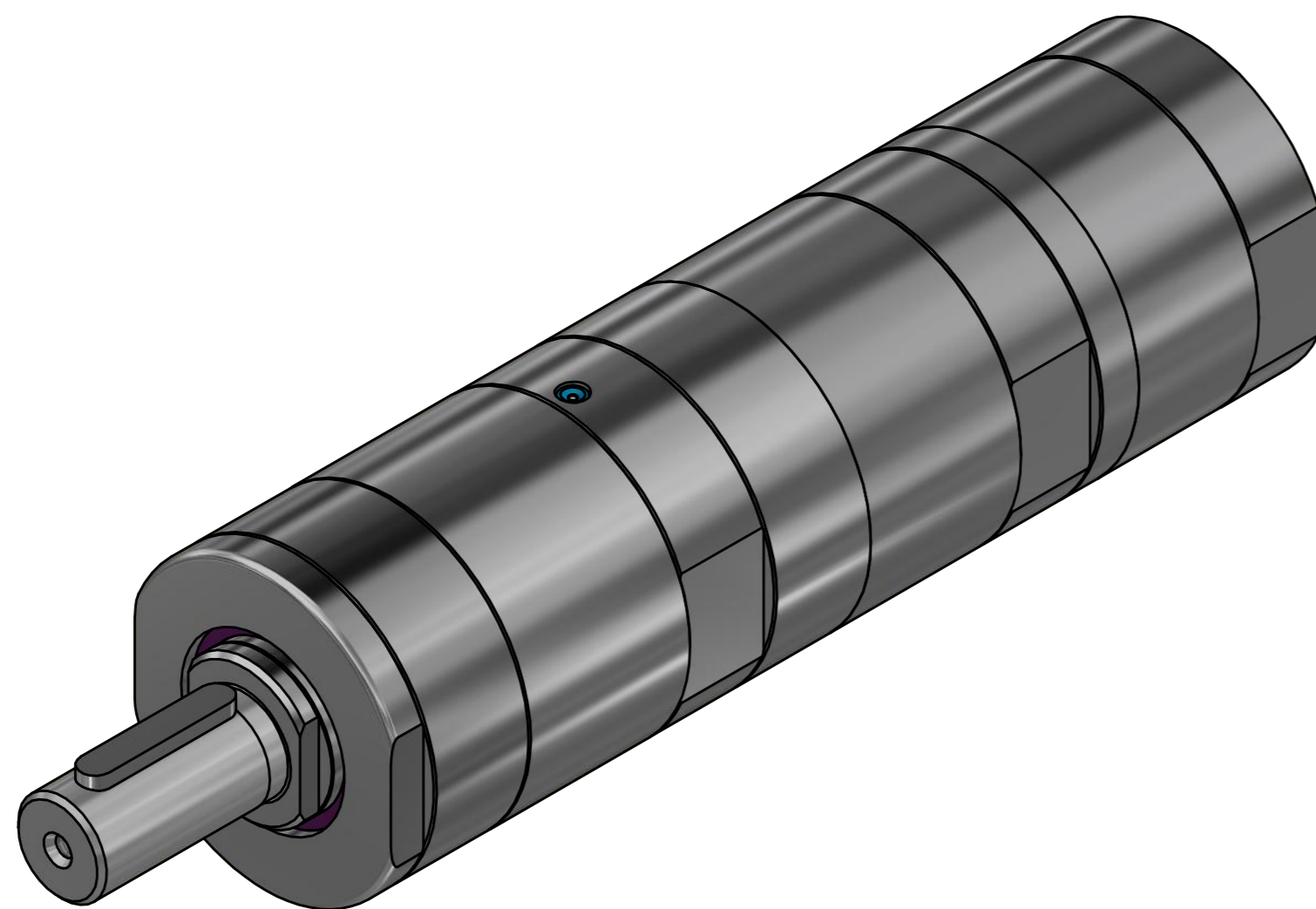
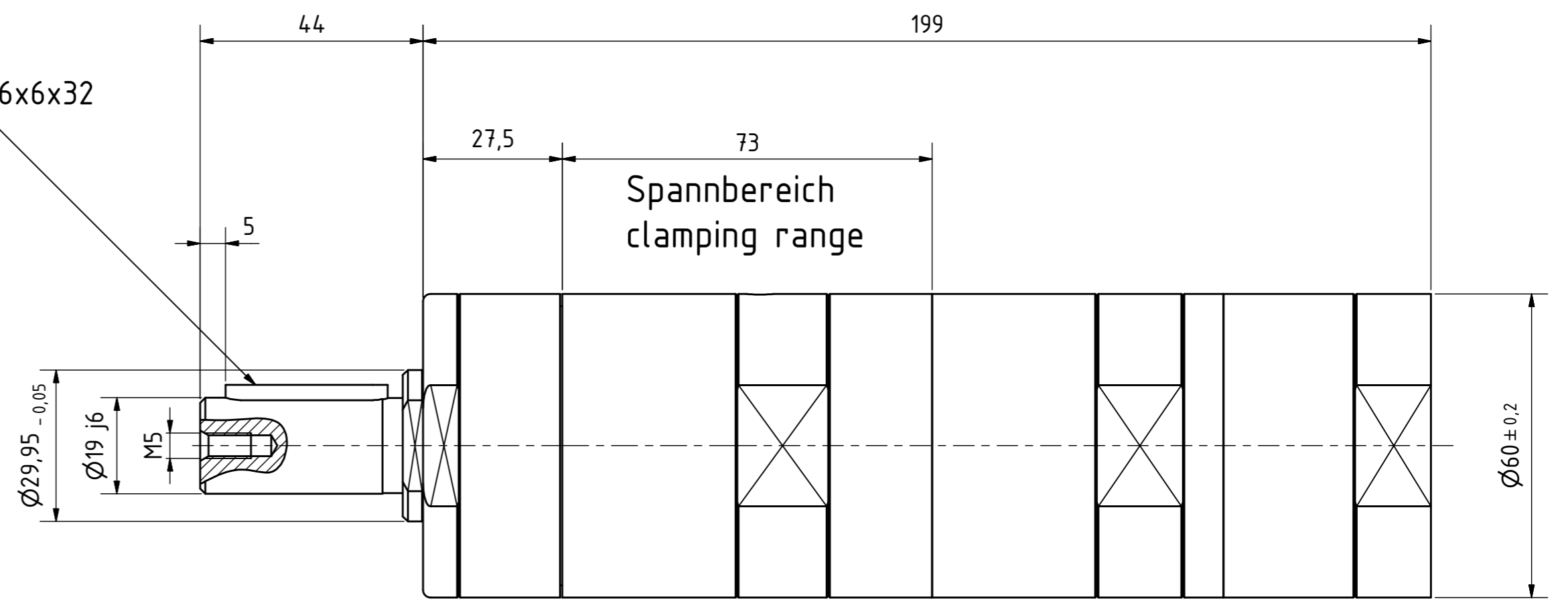

MUD 82-260
60002457

**MANNESMANN
DEMAG**

Änderungsstand:

05.10.2018