

Zuluft
air inlet
Brachement de l'air
Aria in entrata

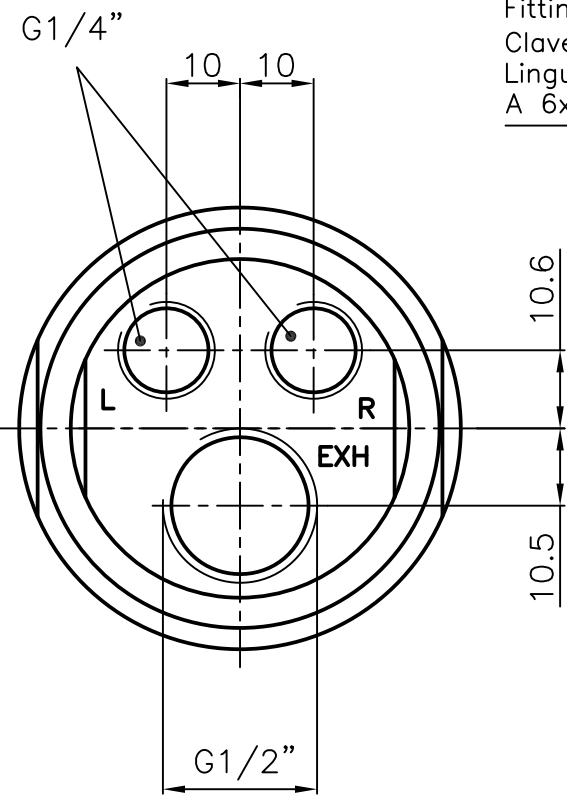

Abluft
exhaust air
Sortie de l'air
Aria in uscita

Paßfeder
Fitting key
Clavette d'ajustage
Linguetta
A 6x6x32 DIN 6885

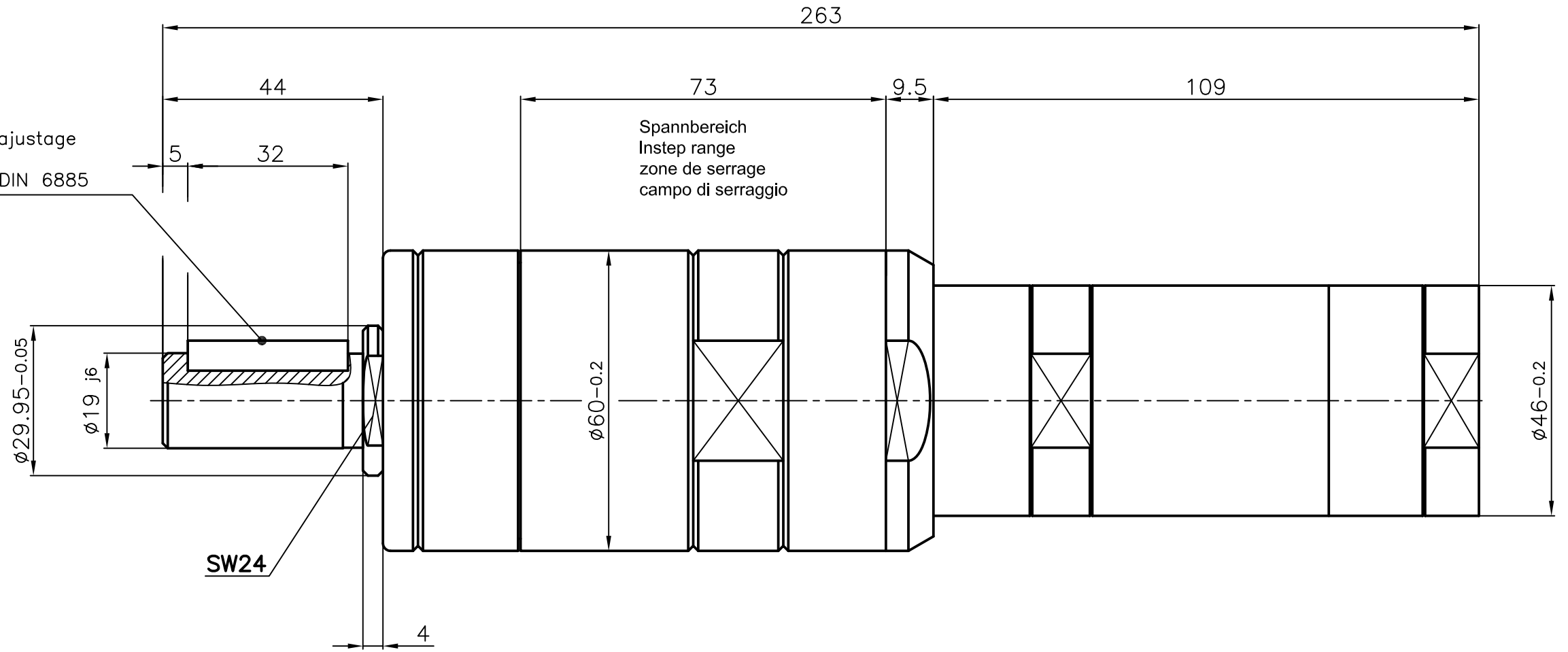

Motor
MUD 62 - 50
60025455