

Aufnahme

Einsteckende R 20 x 60
DIN 8530

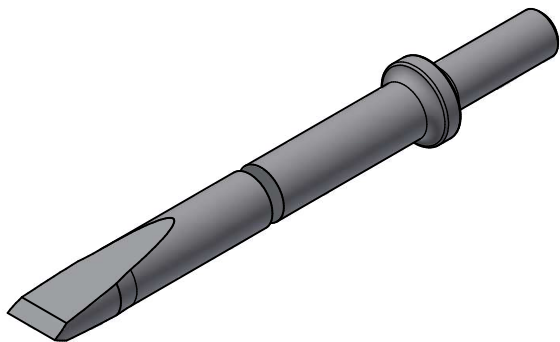
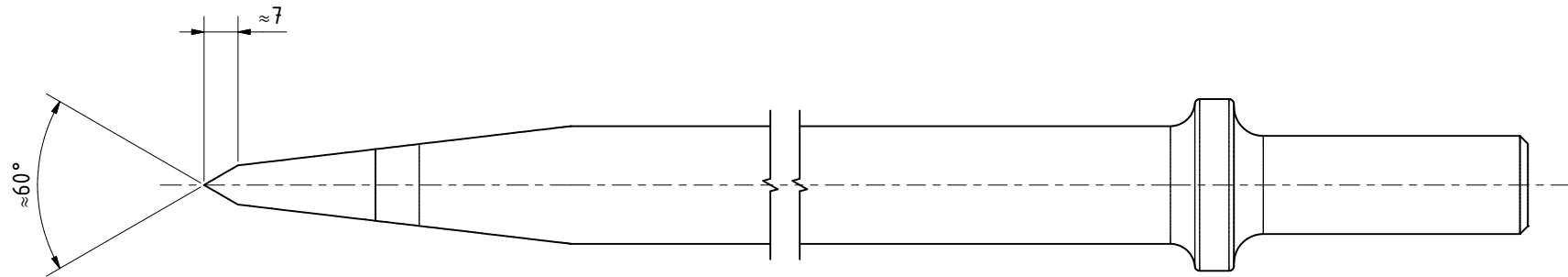
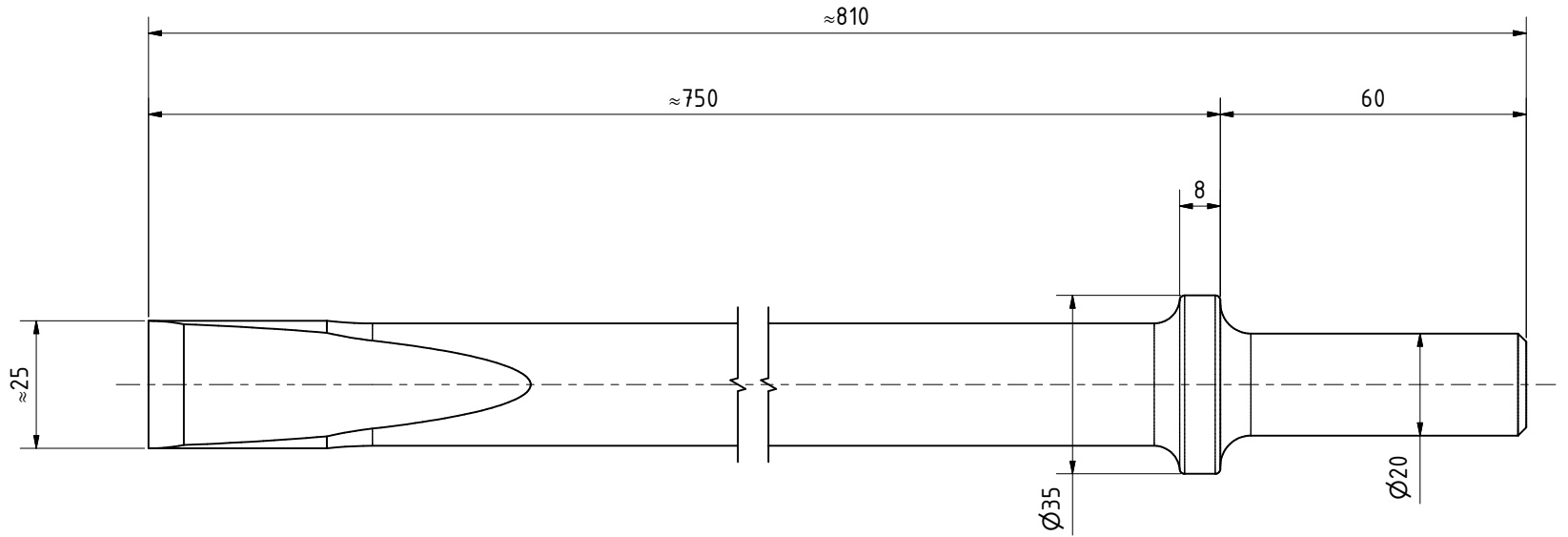
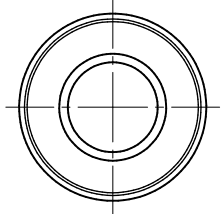

R 20x60 Flach
39507406

MANNESMANN
DEMAG

Änderungsstand: -- 07.09.2023