

Aufnahme

Einsteckende R 20 x 60
DIN 8530

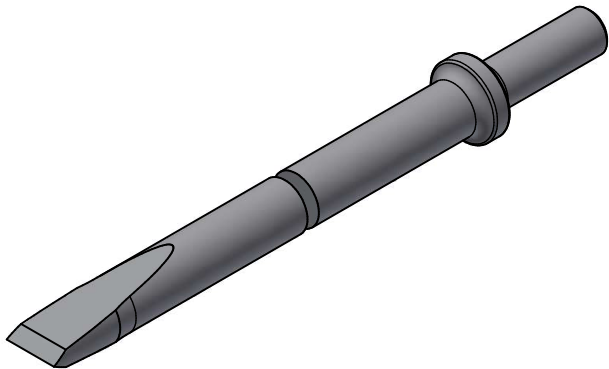
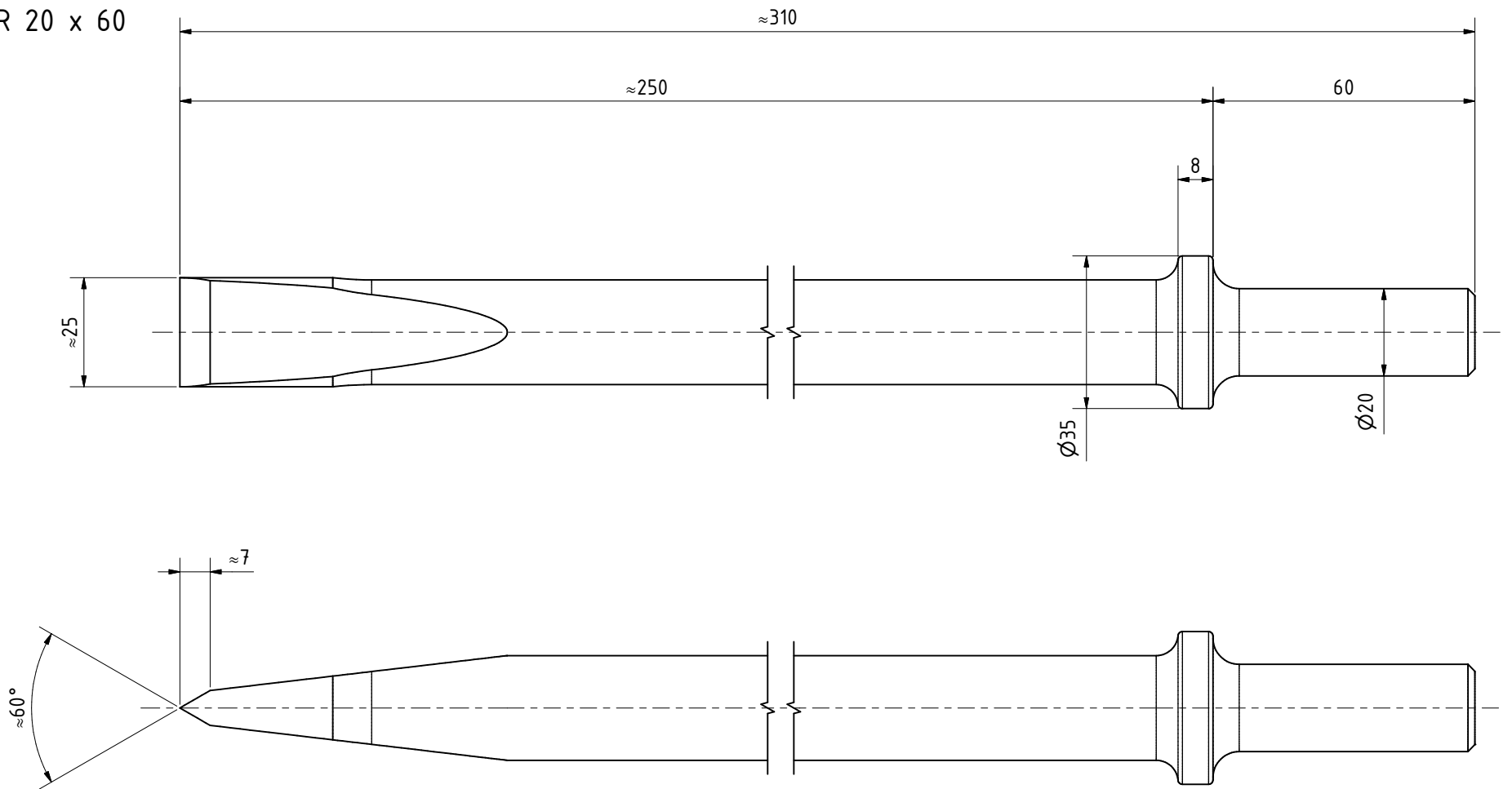
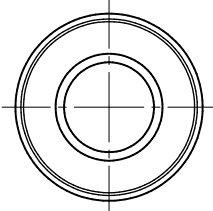

R 20x60 Flach
39507496

MANNESMANN
DEMAG

Änderungsstand: -- 07.09.2023