

Aufnahme

Ø17,5x14,8x60 nach

Einsteckende RS 17,5 DIN 8530

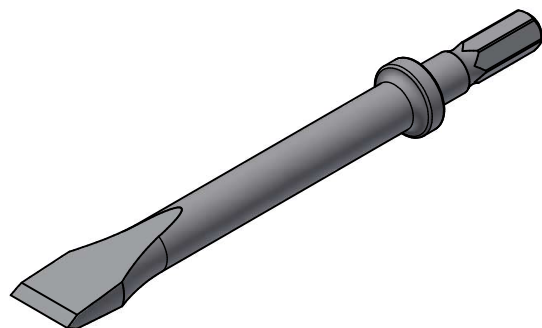
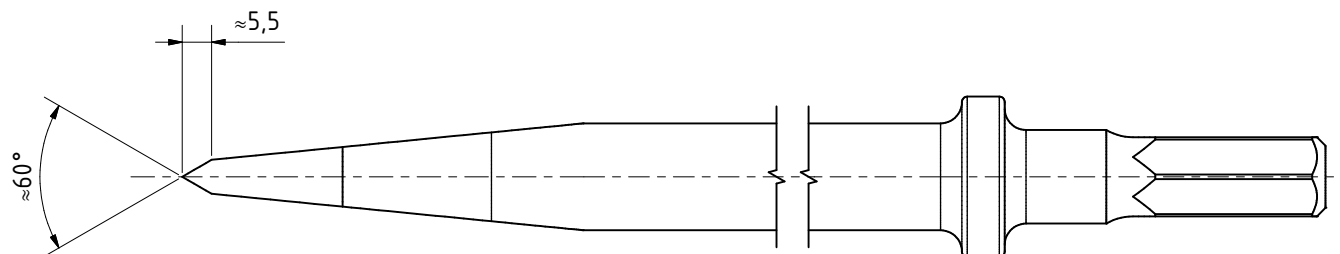
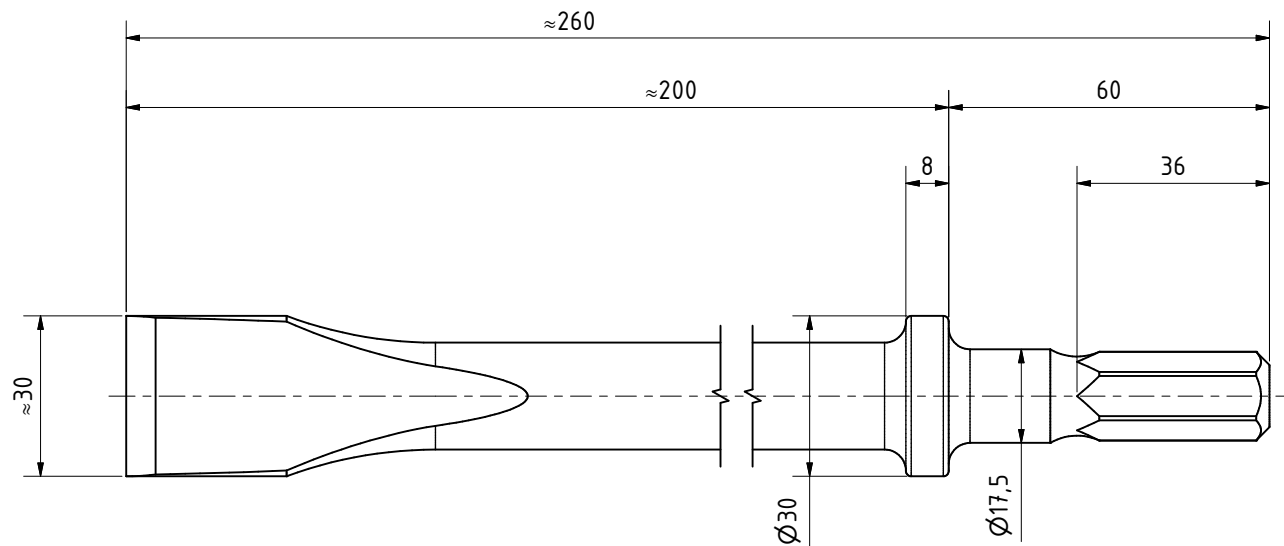
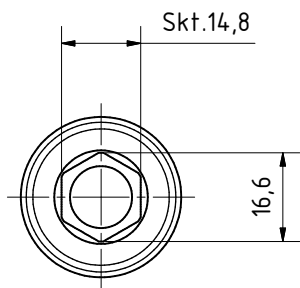

RS17,5x14,8x60 Flach
39506436

MANNESMANN
DEMAG

Änderungsstand: --

06.09.2023