

Aufnahme

Ø17,5x14,8x60 nach

Einsteckende RS 17,5 DIN 8530

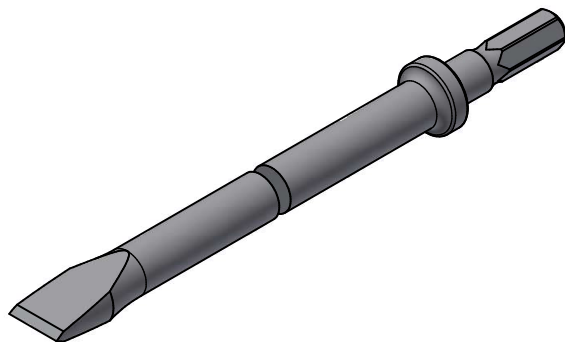
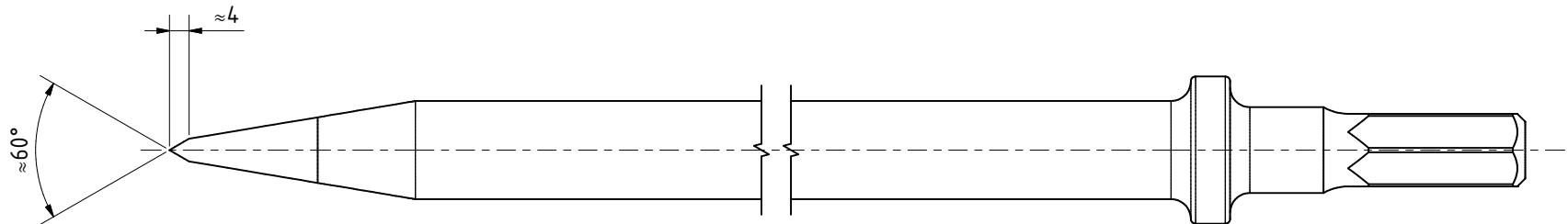
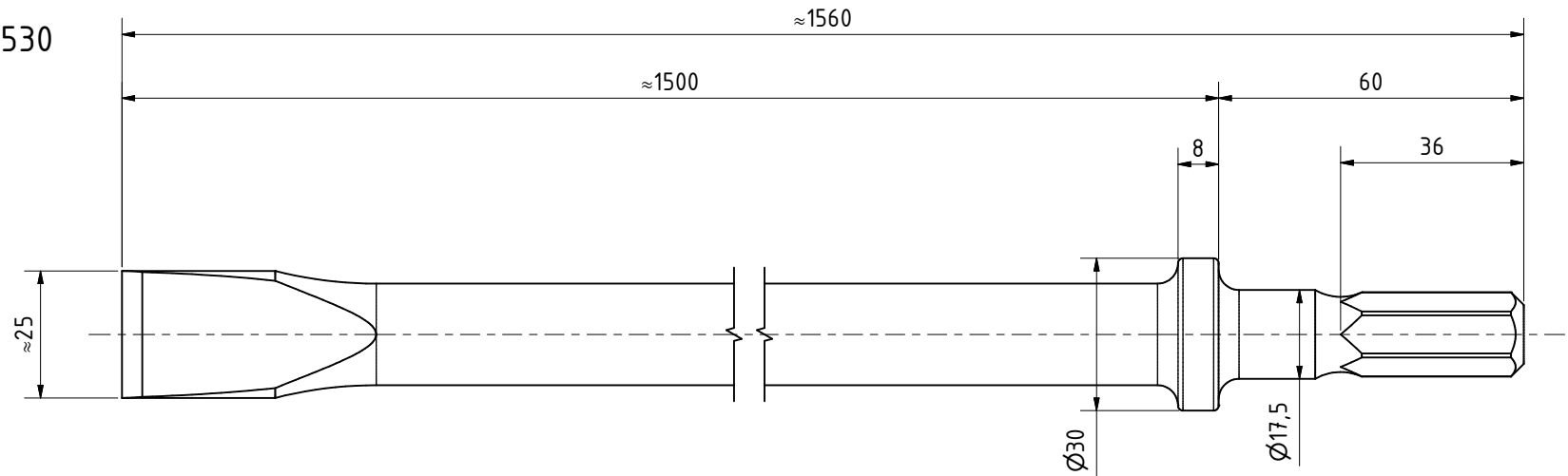
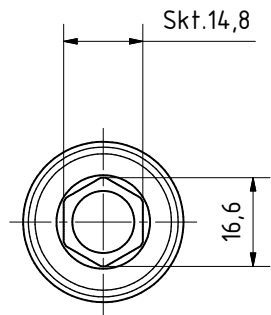

RS 17,5x14,8x60 Flach
39506616

MANNESMANN
DEMAG

Änderungsstand: --

07.09.2023