

Aufnahme

Ø17,5x14,8x60 nach

Einsteckende RS 17,5 DIN 8530

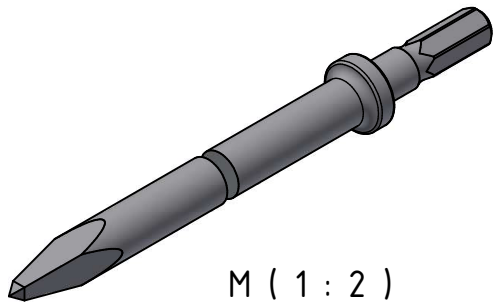
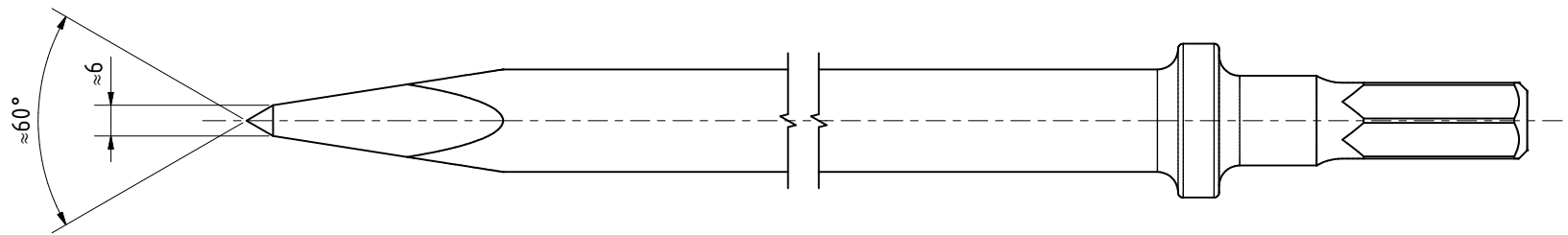
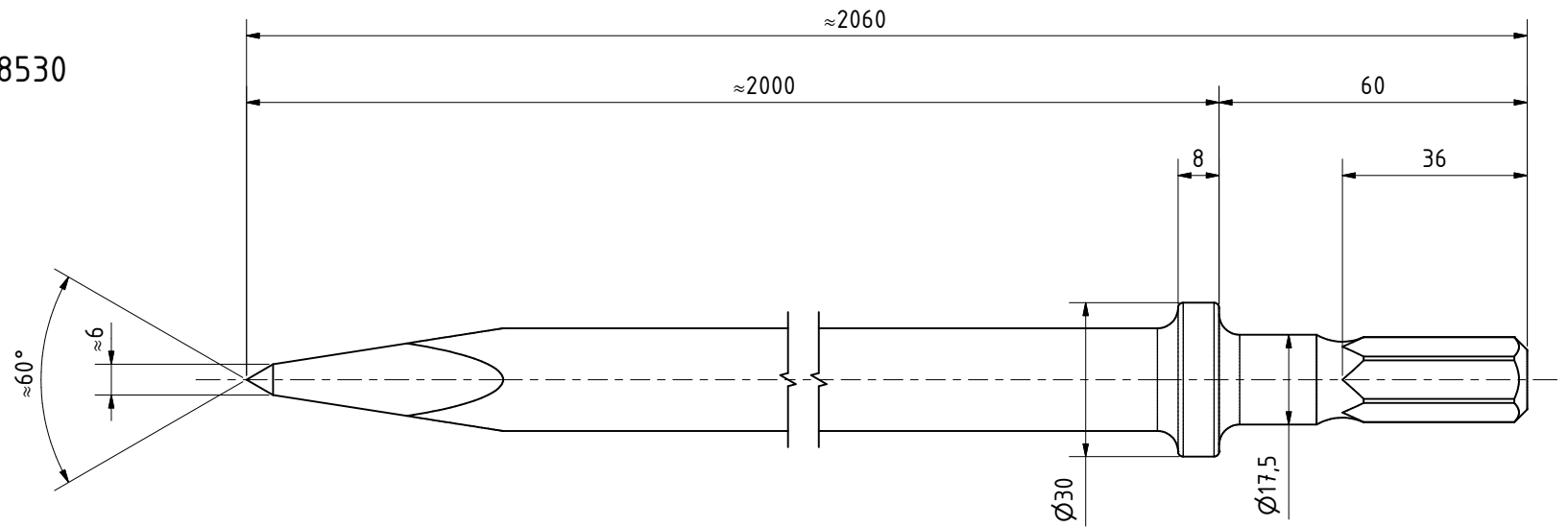
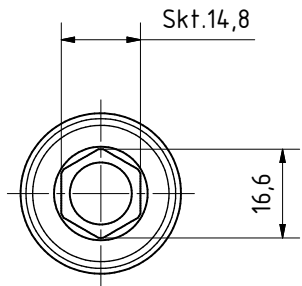

M (1 : 2)

RS17,5x14,8x60 SP
39506516

MANNESMANN
DEMAG

Änderungsstand: -- 07.09.2023