

Aufnahme

Ø20x17x60 nach
Einsteckende RS 20 DIN 8530

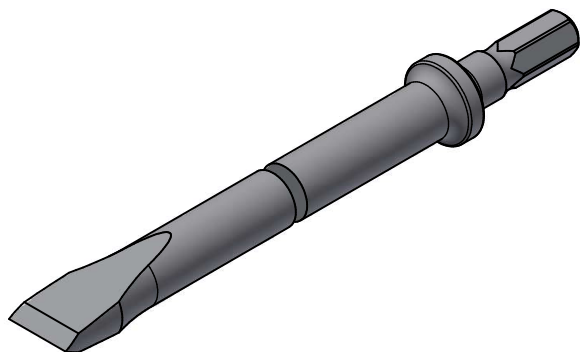
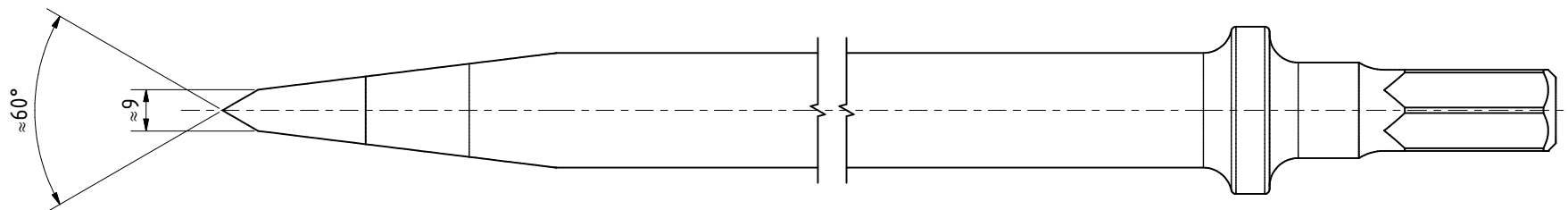
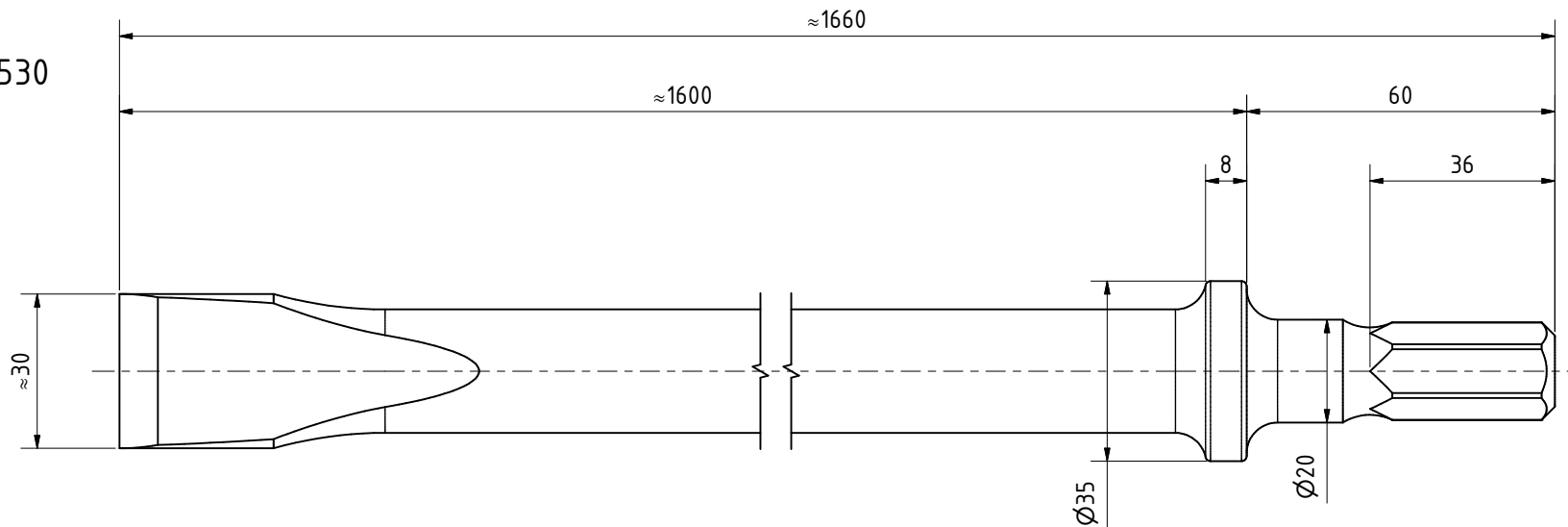
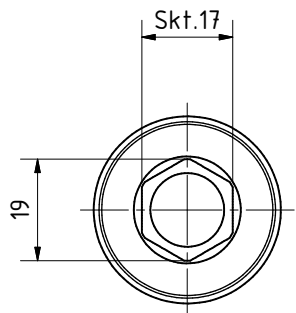

RS20x17x60 Flach
39508516

MANNESMANN
DEMAG

Änderungsstand: --

08.09.2023