

Aufnahme

Ø20x17x60 nach

Einsteckende RS 20 DIN 8530

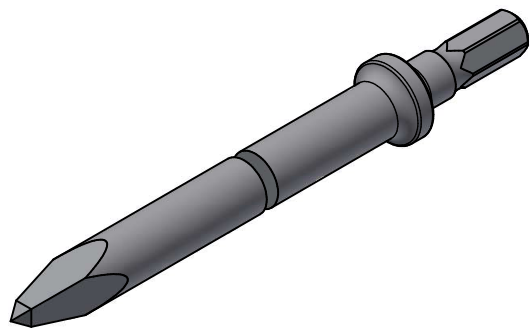
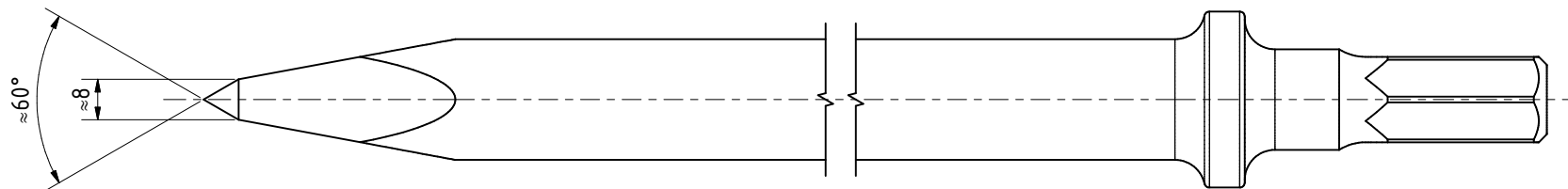
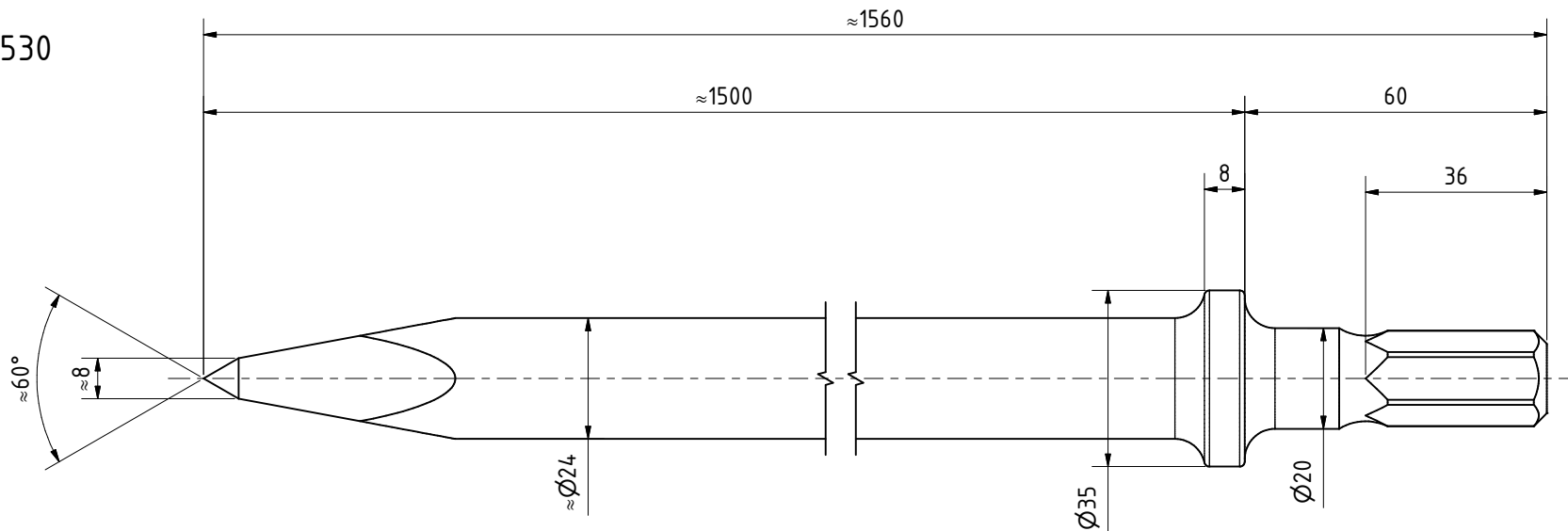
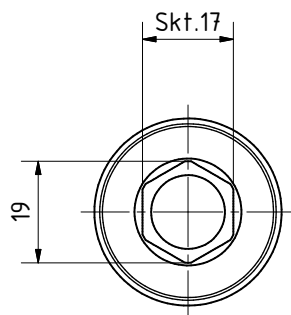

RS20x17x60 Spitz

39508446

MANNESMANN
DEMAG

Änderungsstand: --

08.09.2023