

Aufnahme nach:
Einsteckende
6kt. 19 x 50

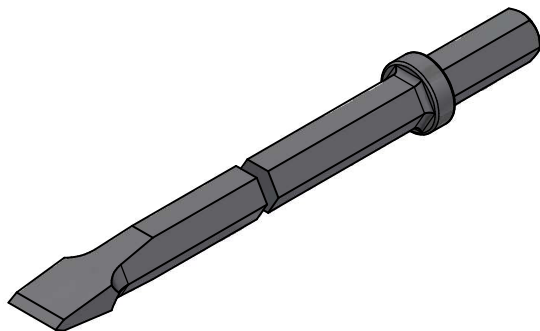
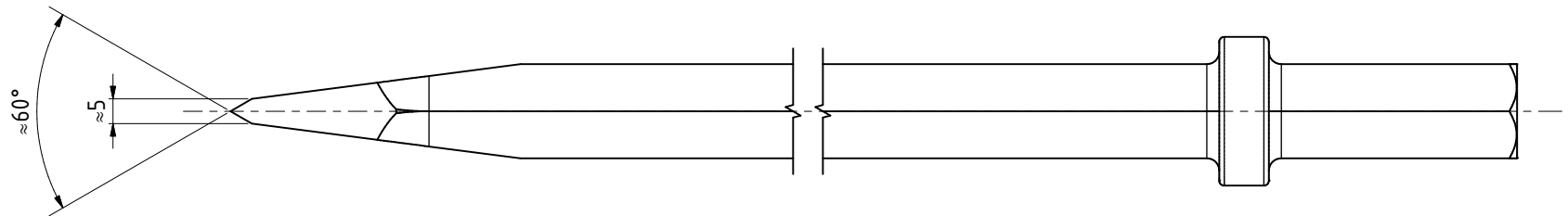
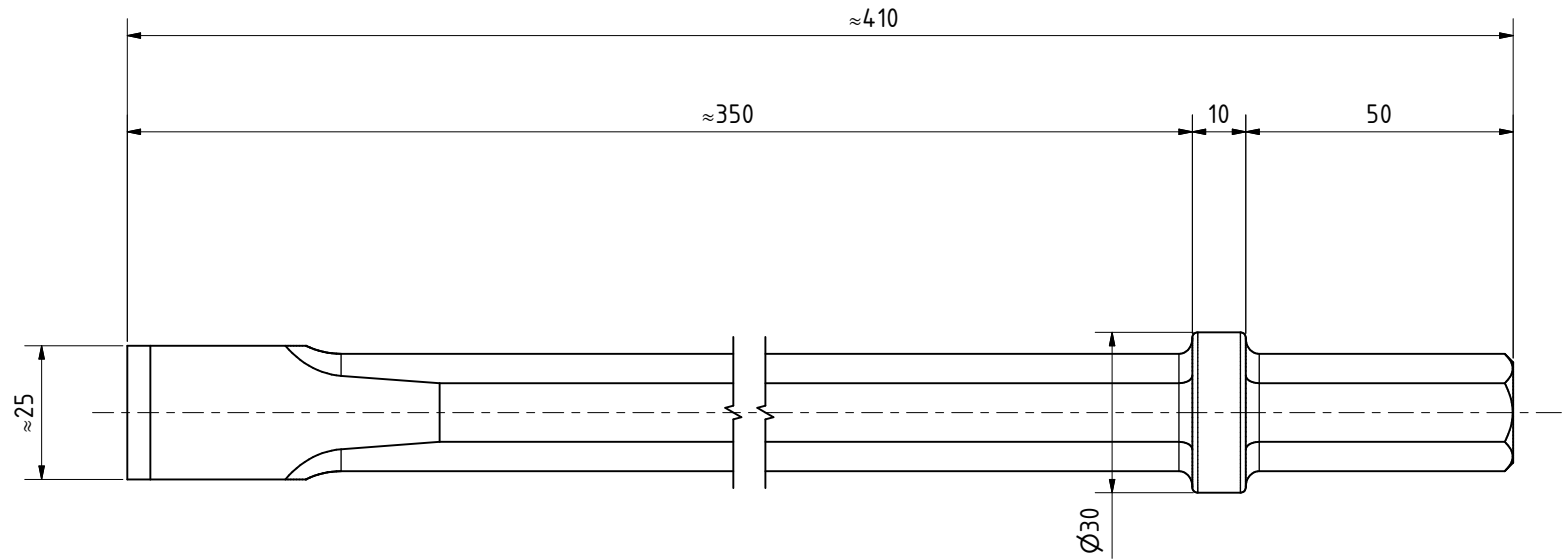
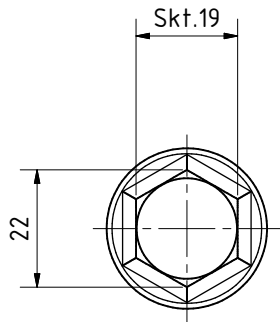

Skt.19x50 Flach
39519586

MANNESMANN
DEMAG

Änderungsstand: --

28.09.2023