

Aufnahme nach:
Einsteckende
6kt. 19 x 50

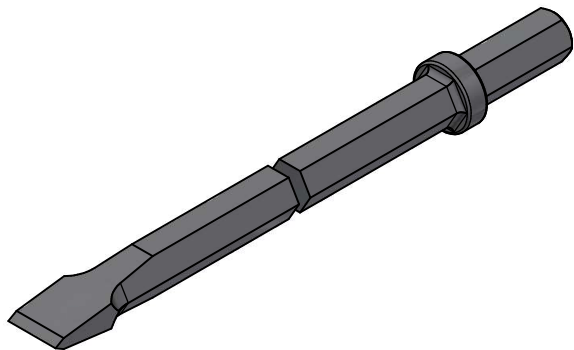
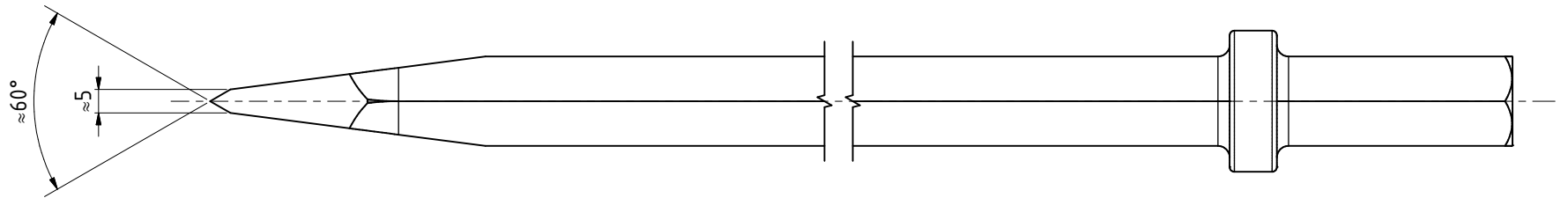
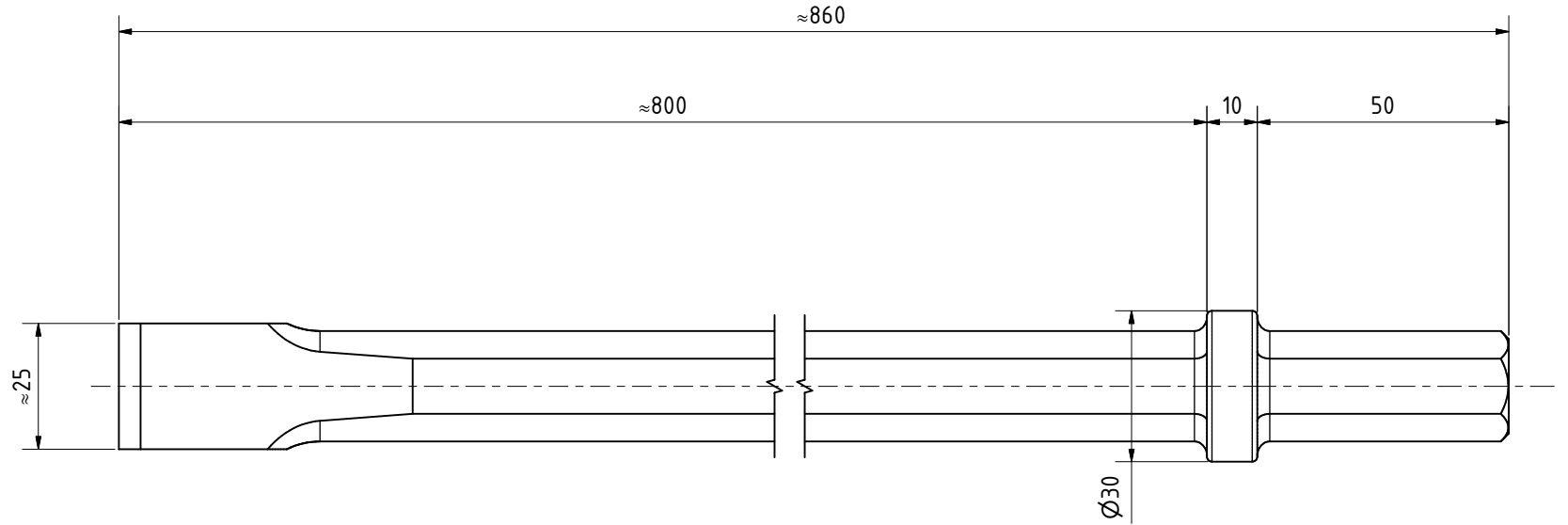
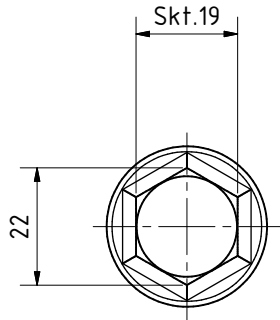

Skt.19x50 Flach
39519656

MANNESMANN
DEMAG

Änderungsstand: -- 13.09.2023