

Aufnahme nach:  
Einsteckende  
22 x 82,5 ISO 1180

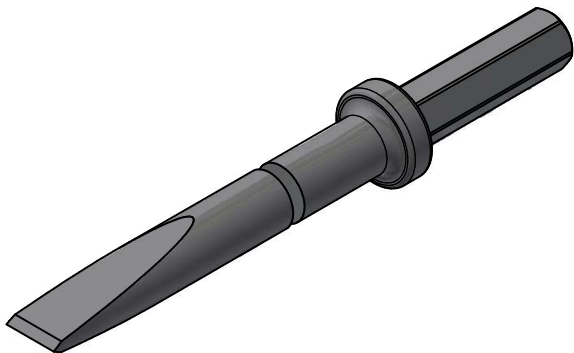
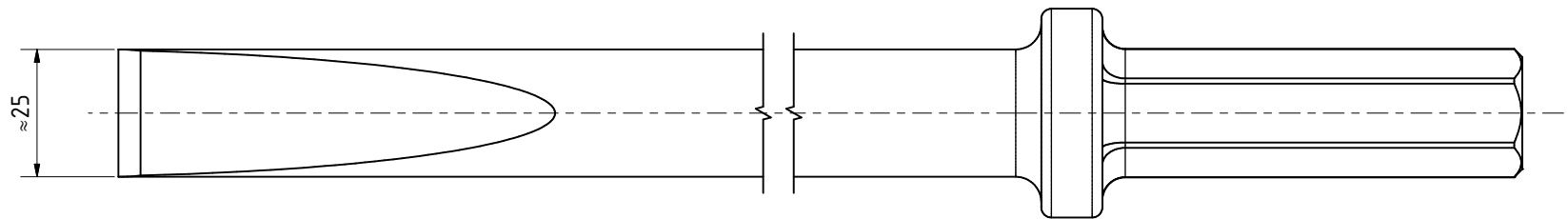
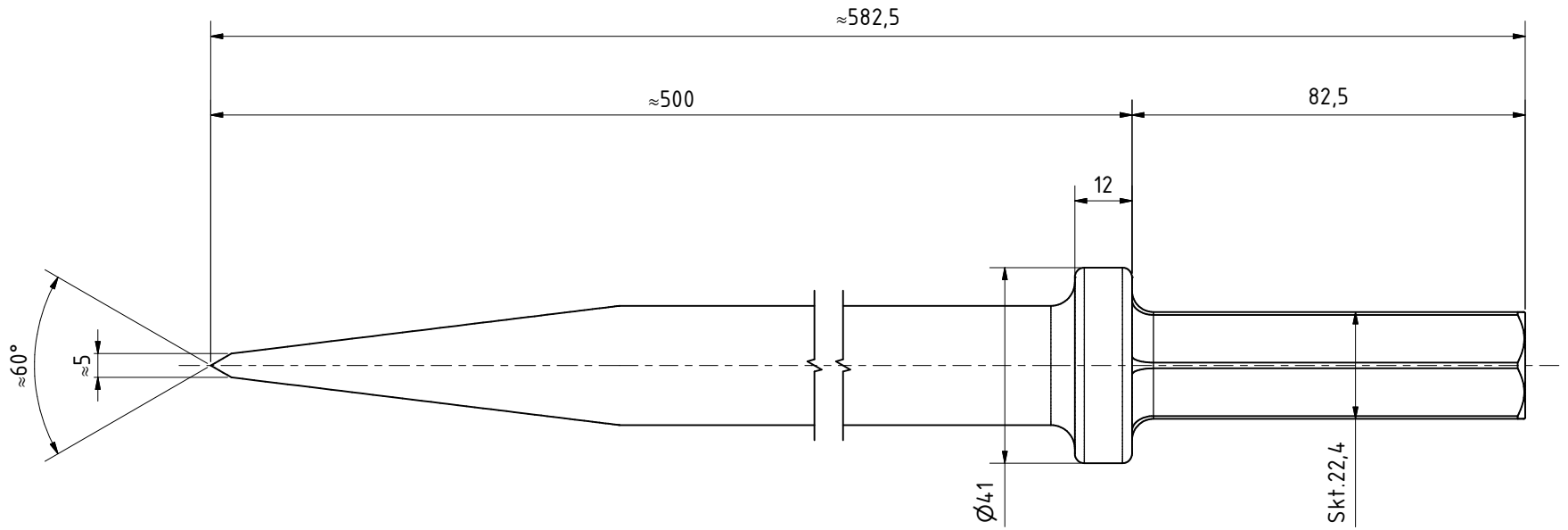
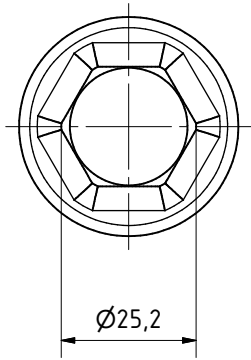

S 22x82,5 Flach  
39511416

**MANNESMANN**  
**DEMAG**

Änderungsstand: -- 12.09.2023