

Passfeder
 feather key
 DIN 6885 - 3x3x18

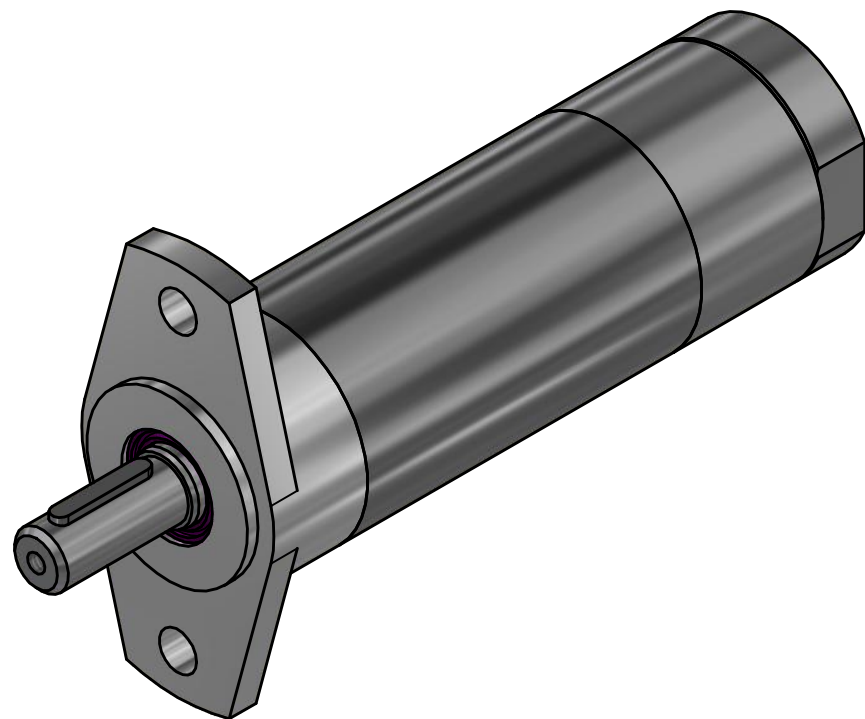
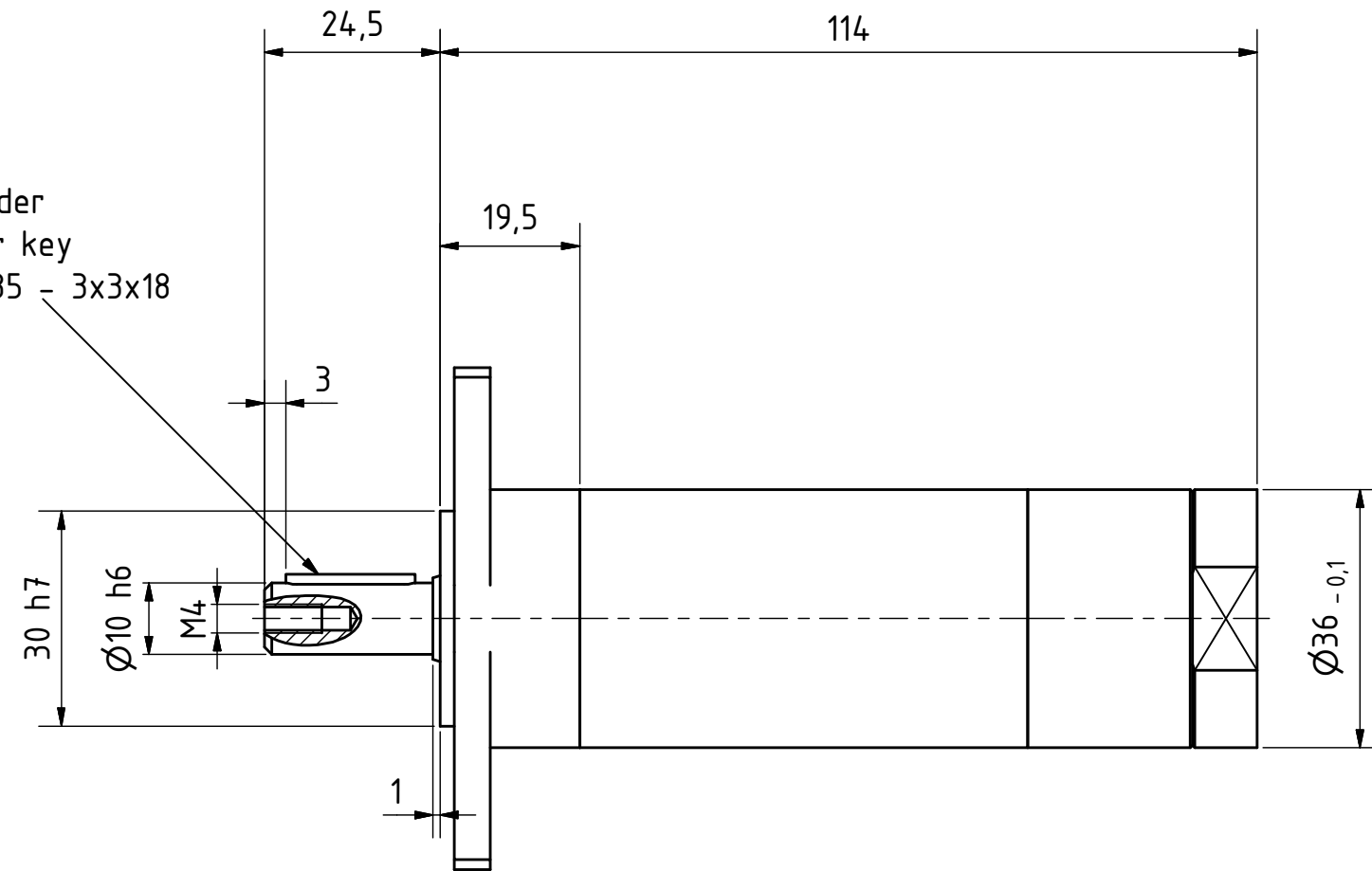

MRD 25-1040 F55
 60003917

MANNESMANN
DEMAC

Änderungsstand: -

31.10.2018