

Paßfeder  
 feather key  
 DIN 6885 - 3x3x18

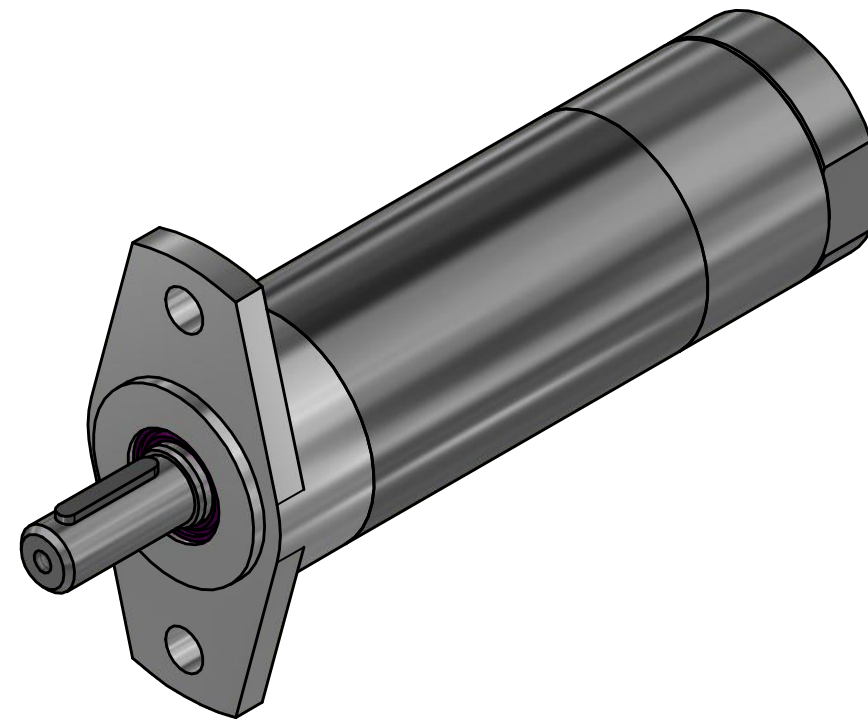
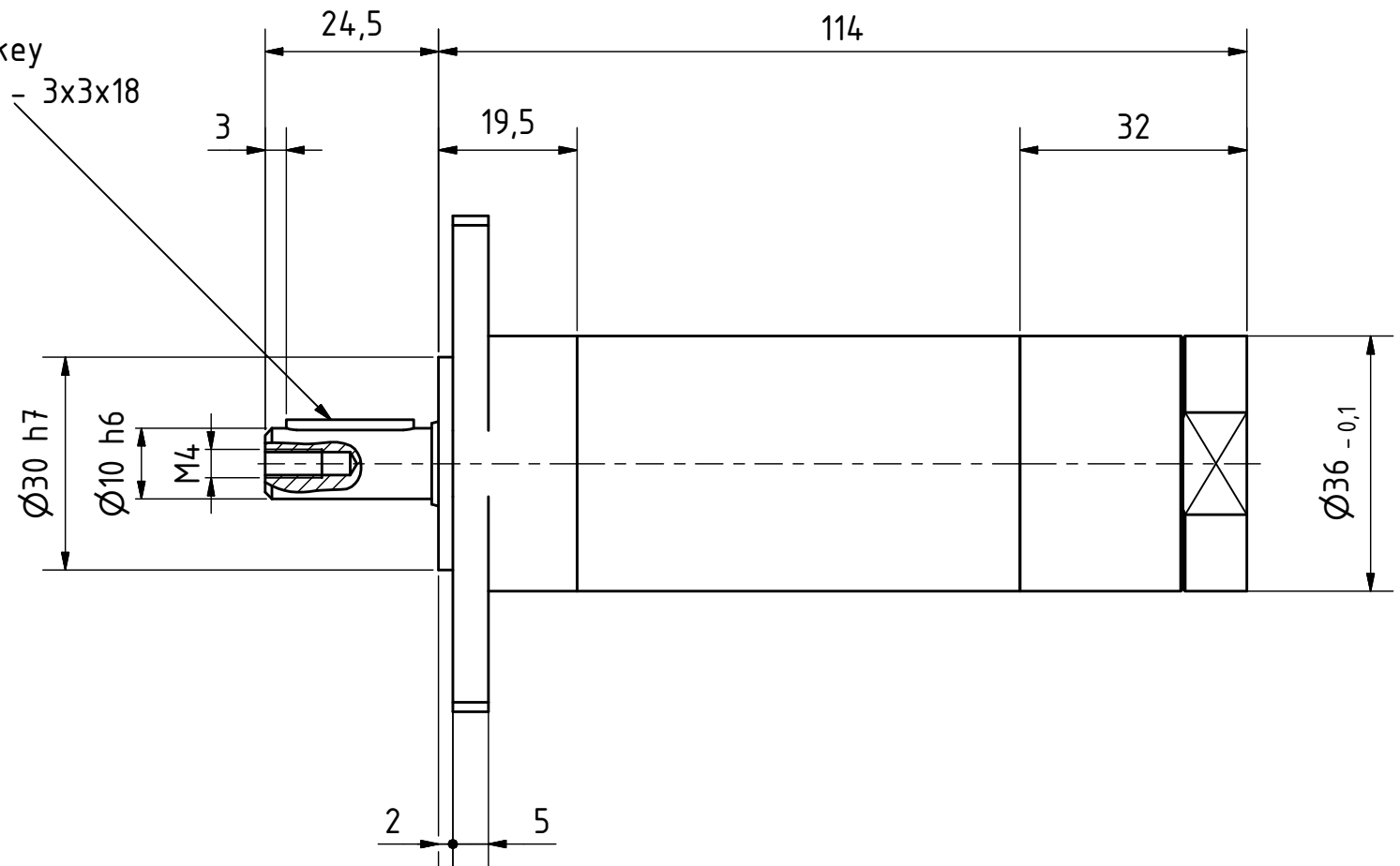

MRD 25-1650 F55  
 60005757

**MANNESMANN**  
**DEMAC**

Änderungsstand: - 14.09.2018