

Paßfeder
feather key
DIN 6885 - 3x3x18

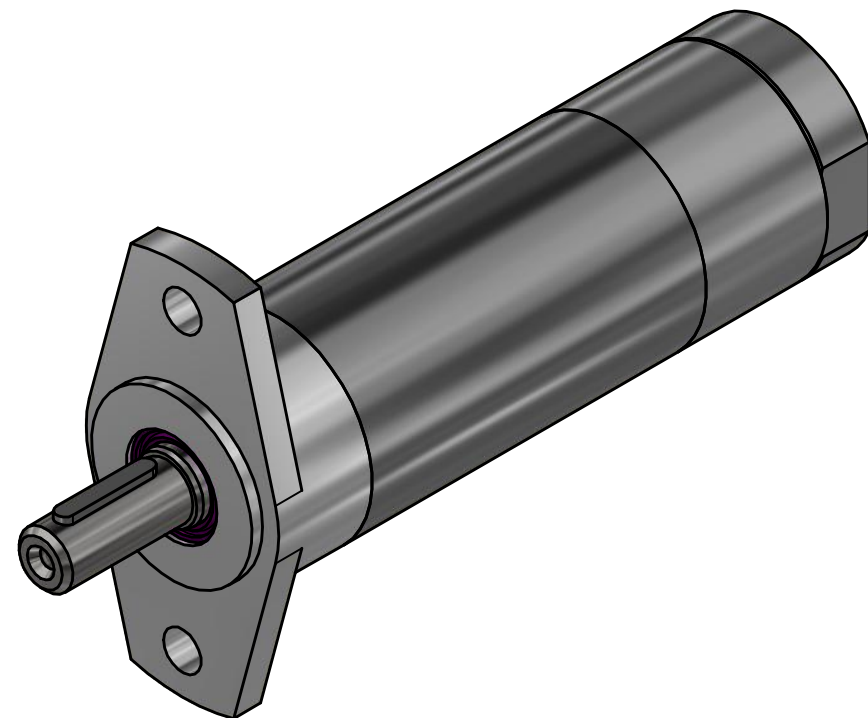
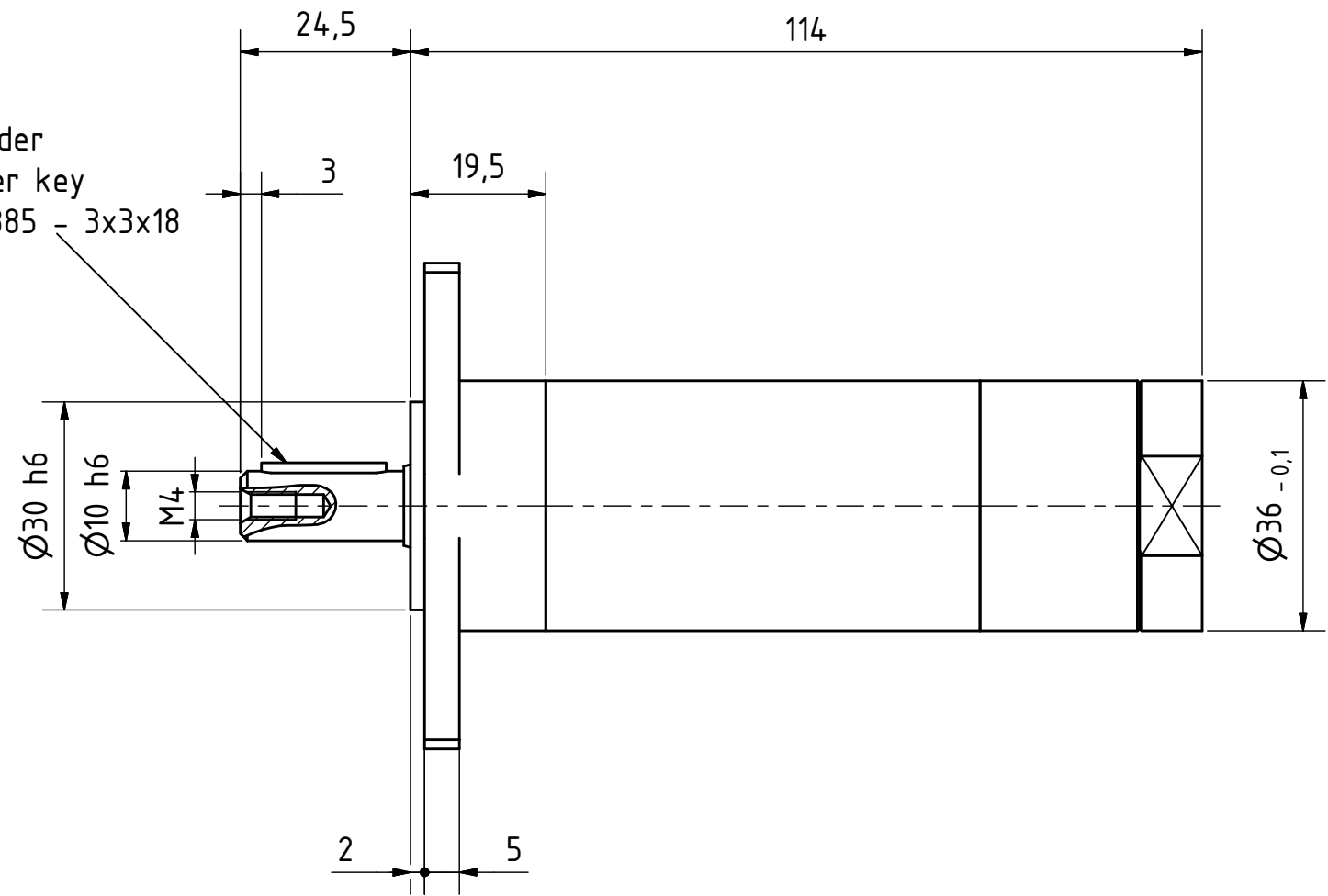

MRD 25-9600 F55
60032597

MANNESMANN
DEMAC

Änderungsstand: - 07.09.2018